

Drives

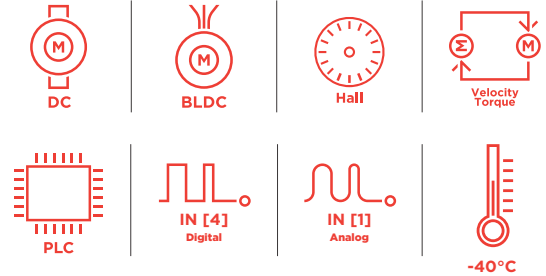

SVTE-A-B40-CanOpen Servo Drives

60VDC | 10A
DC motors, BLDC motors

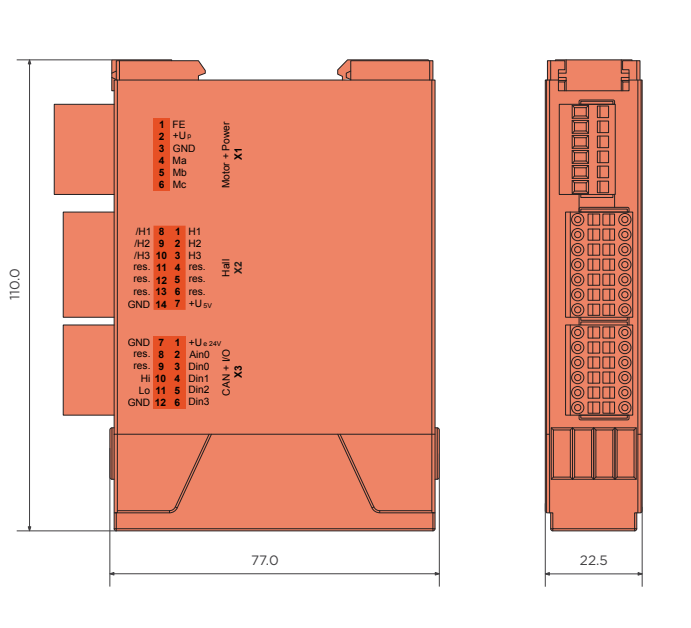

CANopen

Values	Unit
Power	
1 Electronic supply voltage U _e	VDC 9..30
2 Power supply voltage U _p	VDC 9..60
3 Max. output current	A 30
4 Continuous output current @ U _p =24VDC	A 10
5 Continuous output current @ U _p =48VDC	A 8.5
6 Output voltage	Up to 90%
Motor types	
7 DC motors	yes
8 BLDC motors	yes
9 Stepper motors	no
Mechanical	
10 Size LxWxH	mm 110 x 22.5 x 77
CAN bus	
11 Protocol	DS301
12 Galvanically isolated	no
Hall sensors	
13 Input voltage (24VDC tolerant)	VDC 0..5
14 Signal type	differential, open collector, single ended, 5VDC pull up intern 920 Ohm
Digital input	
15 Number	4 (Din0..3)
Analog inputs	
16 Number	1 (Ain0)
Environment	
17 Operating temperature	°C -40...+70

Connection

X1 Motor		
1	FE	Functional earth
2	+Up	Power supply voltage
3	GND	Ground for power supply voltage
4	Ma	Motor phase A
5	Mb	Motor phase B
6	Mc	Motor phase C
X2 Hall and inc. encoder		
1	H1	Hall sensor 1
2	H2	Hall sensor 2
3	H3	Hall sensor 3
4	res.	Reserved
5	res.	Reserved
6	res.	Reserved
7	+U5V	5V output voltage for sensor supply Sensors: encoder, hall
8	/H1	Hall sensor 1 inverted
9	/H2	Hall sensor 2 inverted
10	/H3	Hall sensor 3 inverted
11	res.	Reserved
12	res.	Reserved
13	res.	Reserved
14	GND	Ground for sensor supply (don't connect with system GND)
X3 I/O's and CAN		
1	+Ue24V	Electronic supply voltage
2	Ain0	Analog input 0
3	Din0	Digital input 0
4	Din1	Digital input 1
5	Din2	Digital input 2
6	Din3	Digital input 3
7	GND	Ground for electronic supply voltage
8	res.	Reserved
9	res.	Reserved
10	CAN Hi	CAN High
11	CAN Lo	CAN Low
12	CAN GND	CAN Ground

SVTE-A-E25-CanOpen Servo Drives

60VDC | 35A
DC motors, BLDC motors

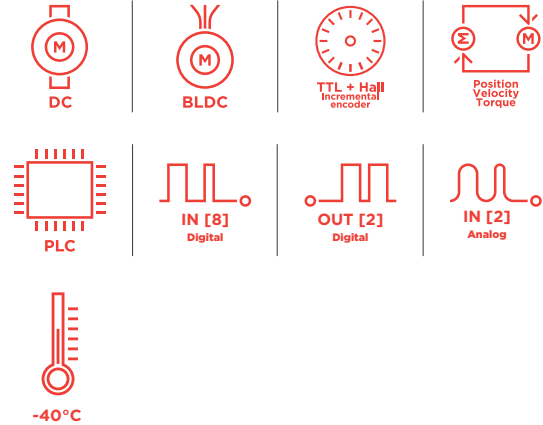
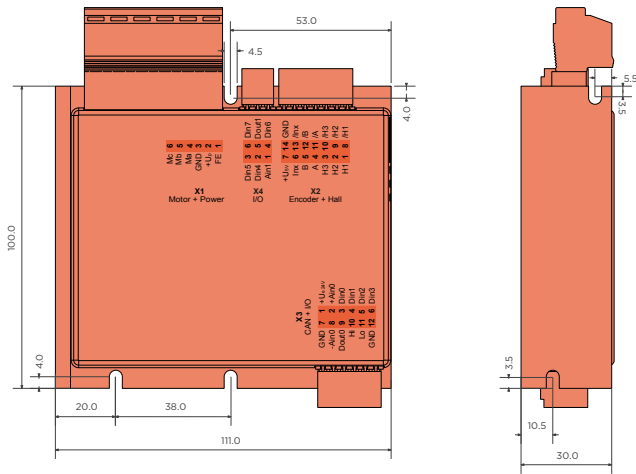

CANopen

Values	Unit
Power	
1 Electronic supply voltage U_e	VDC 9..30
2 Power supply voltage U_p	VDC 9..60
3 Max. output current	A 100
4 Continuous output current @ $U_p=24VDC$	A 35
5 Continuous output current @ $U_p=48VVDC$	A 26
6 Output voltage	Up to 100%
Motor types	
7 DC motors	yes
8 BLDC motors	yes
9 Stepper motors	no
Mechanical	
10 Size LxWxH	mm 111 x 100 x 30
CAN bus	
11 Protocol	DS301
12 Device profile	DS402
13 Galvanically isolated	yes
Incremental encoder	
14 Input voltage (24VDC tolerant)	VDC 0..5
15 Signal type	differential, open collector, single ended
Hall sensors	
16 Input voltage (24VDC tolerant)	VDC 0..5
17 Signal type	differential, open collector, single ended
Digital input	
18 Number	8 (Din0..7)
Digital output	
19 Number	2 (Dout0..1)
20 Continuous output current	A 1.5 (Load: resistive, inductive)
Analog inputs	
21 Number	2 (Ain0..1)
22 Signal type - Ain0	+/- 10 VDC, 12 Bit, differential
23 Signal type - Ain1	+/- 10 VDC, 12 Bit, single ended
Environment	
24 Operating temperature	°C -40...+70

Connection

X1 Motor		
1	FE	Functional earth
2	+Up	Power supply voltage
3	GND	Ground for power supply voltage
4	Ma	Motor phase A
5	Mb	Motor phase B
6	Mc	Motor phase C
X2 Hall and inc. encoder		
1	H1	Hall sensor 1
2	H2	Hall sensor 2
3	H3	Hall sensor 3
4	A	Inc. encoder, A channel
5	B	Inc. encoder, B channel
6	Inx	Inc. encoder, index channel
7	+U5V	5V output voltage for sensor supply Sensors: encoder, hall
8	/H1	Hall sensor 1 inverted
9	/H2	Hall sensor 2 inverted
10	/H3	Hall sensor 3 inverted
11	/A	Inc. encoder, A channel invert
12	/B	Inc. encoder, B channel inverted
13	/Inx	Inc. encoder, index channel inverted
14	GND	Ground for sensor supply (don't connect with system GND)
X3 I/O's and CAN		
1	+Ue24V	Electronic supply voltage
2	+Ain0	Analog input 0, positive
3	Din0	Digital input 0
4	Din1	Digital input 1
5	Din2	Digital input 2
6	Din3	Digital input 3
7	GND	Ground for electronic supply voltage
8	-Ain0	Analog input 0, negative
9	Dout0	Digital output 0
10	CAN Hi	CAN High
11	CAN Lo	CAN Low
12	CAN GND	CAN Ground
X4 I/O's		
1	Ain1	Analog input 1
2	Din4	Digital input 4
3	Din5	Digital input 5
4	Din6	Digital input 6
5	Dout1	Digital output 1
6	Din7	Digital input 7

SVTE-A-E25-EtherCAT Servo Drives

60VDC | 35A
DC motors, BLDC motors

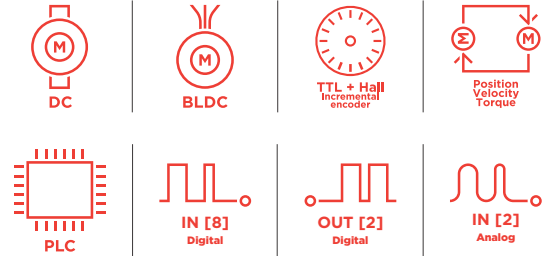
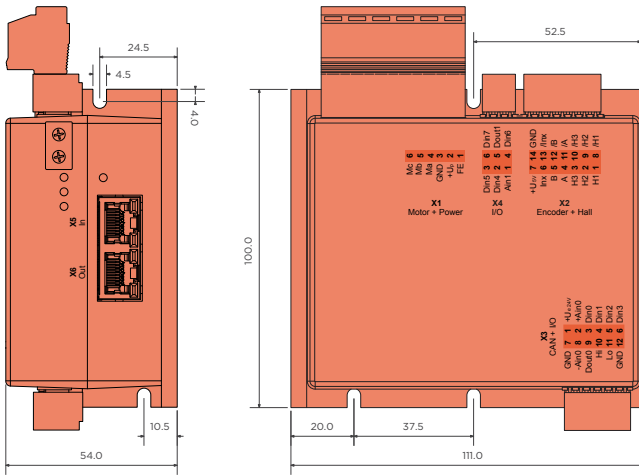

CANopen | EtherCAT

Values	Unit
Power	
1 Electronic supply voltage Ue	VDC 9..30
2 Power supply voltage Up	VDC 9..60
3 Max. output current	A 100
4 Continuous output current @ Up=24VDC	A 35
5 Continuous output current @ Up=48VDC	A 26
6 Output voltage	Up to 100%
Motor types	
7 DC motors	yes
8 BLDC motors	yes
9 Stepper motors	no
Mechanical	
10 Size LxWxH	mm 111 x 100 x 54
CAN bus	
11 Protocol	DS301
12 Device profile	DS402
13 Galvanically isolated	yes
EtherCAT	
14 Type	EtherCAT Slave
15 Physical layer	100 Base-Tx EtherCAT
16 Max. baudrate	100 Mbit/s
17 Number of ports	2xRJ45 (In,Out)
18 Protocol	CoE (CANopen over EtherCAT)
Incremental encoder	
19 Input voltage (24VDC tolerant)	VDC 0..5
20 Signal type	differential, open collector, single ended
Hall sensors	
21 Input voltage (24VDC tolerant)	VDC 0..5
22 Signal type	differential, open collector, single ended
Digital input	
23 Number	8 (Din0..7)
Digital output	
24 Number	2 (Dout0..1)
25 Continuous output current	A 1.5 (Load: resistive, inductive)
Analog inputs	
26 Number	2 (Ain0..1)
27 Signal type - Ain0	+/- 10 VDC, 12 Bit, differential
28 Signal type - Ain1	+/- 10 VDC, 12 Bit, single ended
Environment	
29 Operating temperature	°C -25...+70

Connection

X1 Motor		
1	FE	Functional earth
2	+Up	Power supply voltage
3	GND	Ground for power supply voltage
4	Ma	Motor phase A
5	Mb	Motor phase B
6	Mc	Motor phase C
X2 Hall and inc. encoder		
1	H1	Hall sensor 1
2	H2	Hall sensor 2
3	H3	Hall sensor 3
4	A	Inc. encoder, A channel
5	B	Inc. encoder, B channel
6	Inx	Inc. encoder, index channel
7	+U5V	5V output voltage for sensor supply Sensors: encoder, hall
8	/H1	Hall sensor 1 inverted
9	/H2	Hall sensor 2 inverted
10	/H3	Hall sensor 3 inverted
11	/A	Inc. encoder, A channel invert
12	/B	Inc. encoder, B channel inverted
13	/Inx	Inc. encoder, index channel inverted
14	GND	Ground for sensor supply (don't connect with system GND)
X3 I/O's and CAN		
1	+Ue24V	Electronic supply voltage
2	+Ain0	Analog input 0, positive
3	Din0	Digital input 0
4	Din1	Digital input 1
5	Din2	Digital input 2
6	Din3	Digital input 3
7	GND	Ground for electronic supply voltage
8	-Ain0	Analog input 0, negative
9	Dout0	Digital output 0
10	CAN Hi	CAN High
11	CAN Lo	CAN Low
12	CAN GND	CAN Ground
X4 I/O's		
1	Ain1	Analog input 1
2	Din4	Digital input 4
3	Din5	Digital input 5
4	Din6	Digital input 6
5	Dout1	Digital output 1
6	Din7	Digital input 7
X5 EtherCAT - In port		
X6 EtherCAT - Out port		

SVTE-A-E40-CanOpen Servo Drives

60VDC | 10A
DC motors, BLDC motors

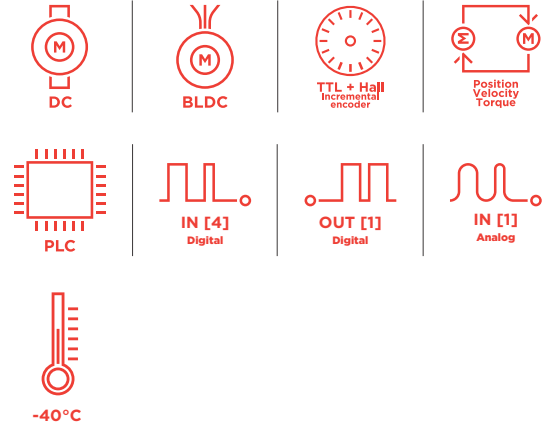
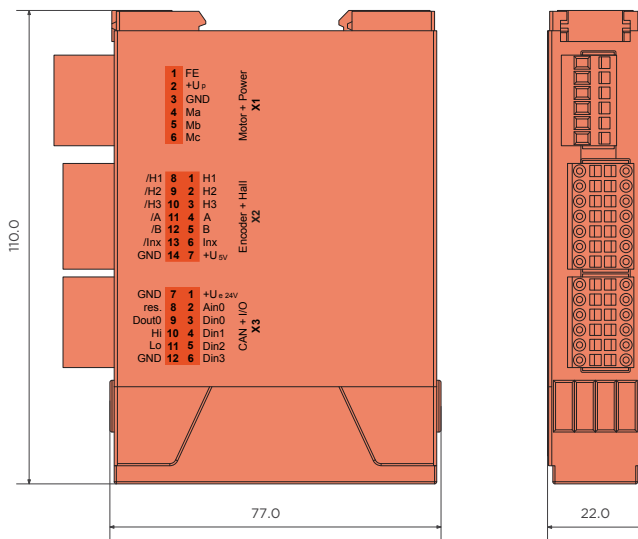

CANopen

Values	Unit
Power	
1 Electronic supply voltage U _e	VDC 9..30
2 Power supply voltage U _p	VDC 9..60
3 Max. output current	A 30
4 Continuous output current @ U _p =24VDC	A 10
5 Continuous output current @ U _p =48VDC	A 8.5
6 Output voltage	Up to 90%
Motor types	
7 DC motors	yes
8 BLDC motors	yes
9 Stepper motors	no
Mechanical	
10 Size LxWxH	mm 110 x 22.5 x 77
CAN bus	
11 Protocol	DS301
12 Device profile	DS402
13 Galvanically isolated	yes
Incremental encoder	
14 Input voltage (24VDC tolerant)	VDC 0..5
15 Signal type	differential, open collector, single ended
Hall sensors	
16 Input voltage (24VDC tolerant)	VDC 0..5
17 Signal type	differential, open collector, single ended
Digital input	
18 Number	4 (Din0..3)
Digital output	
19 Number	1 (Dout0..1)
20 Continuous output current	A 1.5 (Load: resistive, inductive)
Analog inputs	
21 Number	1 (Ain0..1)
22 Signal type	0..10 VDC, 12 Bit, single ended
Environment	
23 Operating temperature	°C -40...+70

Connection

X1 Motor		
1	FE	Functional earth
2	+Up	Power supply voltage
3	GND	Ground for power supply voltage
4	Ma	Motor phase A
5	Mb	Motor phase B
6	Mc	Motor phase C
X2 Hall and inc. encoder		
1	H1	Hall sensor 1
2	H2	Hall sensor 2
3	H3	Hall sensor 3
4	A	Inc. encoder, A channel
5	B	Inc. encoder, B channel
6	Inx	Inc. encoder, index channel
7	+U5V	5V output voltage for sensor supply Sensors: encoder, hall
8	/H1	Hall sensor 1 inverted
9	/H2	Hall sensor 2 inverted
10	/H3	Hall sensor 3 inverted
11	/A	Inc. encoder, A channel invert
12	/B	Inc. encoder, B channel inverted
13	/Inx	Inc. encoder, index channel inverted
14	GND	Ground for sensor supply (don't connect with system GND)
X3 I/O's and CAN		
1	+Ue24V	Electronic supply voltage
2	Ain0	Analog input 0
3	Din0	Digital input 0
4	Din1	Digital input 1
5	Din2	Digital input 2
6	Din3	Digital input 3
7	GND	Ground for electronic supply voltage
8	res.	Reserved
9	Dout0	Digital output 0
10	CAN Hi	CAN High
11	CAN Lo	CAN Low
12	CAN GND	CAN Ground

SVTE-A-E40-EtherCAT Servo Drives

60VDC | 10A
DC motors, BLDC motors

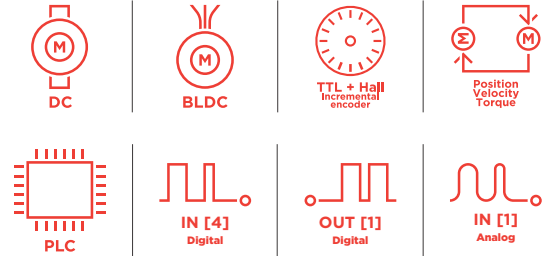
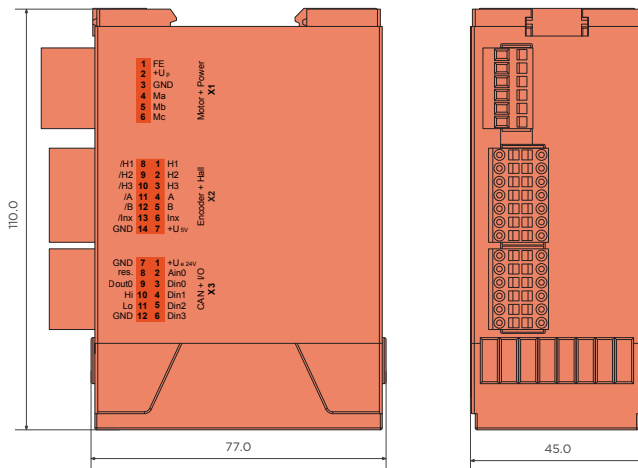

CANopen | EtherCAT

Values	Unit
Power	
1 Electronic supply voltage U _e	VDC 9..30
2 Power supply voltage U _p	VDC 9..60
3 Max. output current	A 30
4 Continuous output current @ U _p =24VDC	A 10
5 Continuous output current @ U _p =48VDC	A 8.5
6 Output voltage	Up to 90%
Motor types	
7 DC motors	yes
8 BLDC motors	yes
9 Stepper motors	no
Mechanical	
10 Size LxWxH	mm 110 x 45 x 77
CAN bus	
11 Protocol	DS301
12 Device profile	DS402
13 Galvanically isolated	no
EtherCAT	
14 Type	EtherCAT Slave
15 Physical layer	100 Base-Tx EtherCAT
16 Max. baudrate	100 Mbit/s
17 Number of ports	2xRJ45 (In,Out)
18 Protocol	CoE (CANopen over EtherCAT)
Incremental encoder	
19 Input voltage (24VDC tolerant)	VDC 0..5
20 Signal type	differential, open collector, single ended
Hall sensors	
21 Input voltage (24VDC tolerant)	VDC 0..5
22 Signal type	differential, open collector, single ended
Digital input	
23 Number	4 (Din0..3)
Digital output	
24 Number	1 (Dout0..1)
25 Continuous output current	A 1.5 (Load: resistive, inductive)
Analog inputs	
26 Number	1 (Ain0..1)
27 Signal type - Ain0	0..10 VDC, 12 Bit, single ended
Environment	
28 Operating temperature	°C -25...+70

Connection

X1 Motor		
1	FE	Functional earth
2	+Up	Power supply voltage
3	GND	Ground for power supply voltage
4	Ma	Motor phase A
5	Mb	Motor phase B
6	Mc	Motor phase C
X2 Hall and inc. encoder		
1	H1	Hall sensor 1
2	H2	Hall sensor 2
3	H3	Hall sensor 3
4	A	Inc. encoder, A channel
5	B	Inc. encoder, B channel
6	Inx	Inc. encoder, index channel
7	+U5V	5V output voltage for sensor supply Sensors: encoder, hall
8	/H1	Hall sensor 1 inverted
9	/H2	Hall sensor 2 inverted
10	/H3	Hall sensor 3 inverted
11	/A	Inc. encoder, A channel invert
12	/B	Inc. encoder, B channel inverted
13	/Inx	Inc. encoder, index channel inverted
14	GND	Ground for sensor supply (don't connect with system GND)
X3 I/O's and CAN		
1	+Ue24V	Electronic supply voltage
2	Ain0	Analog input 0
3	Din0	Digital input 0
4	Din1	Digital input 1
5	Din2	Digital input 2
6	Din3	Digital input 3
7	GND	Ground for electronic supply voltage
8	res.	Reserved
9	Dout0	Digital output 0
10	CAN Hi	CAN High
11	CAN Lo	CAN Low
12	CAN GND	CAN Ground
X5 EtherCAT - In port		
X6 EtherCAT - Out port		

SVTE-A-E45-CanOpen Servo Drives

60VDC | 10A
DC motors, BLDC motors

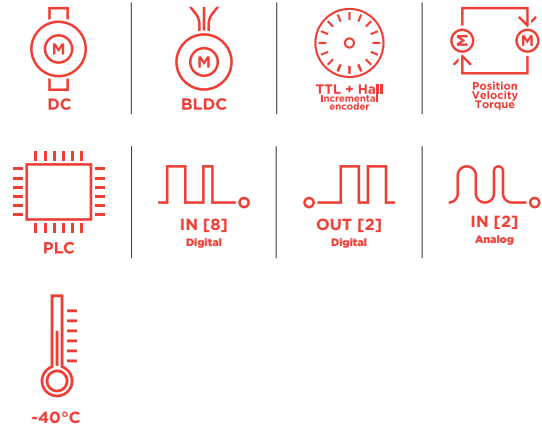
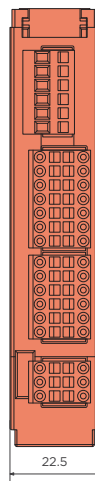
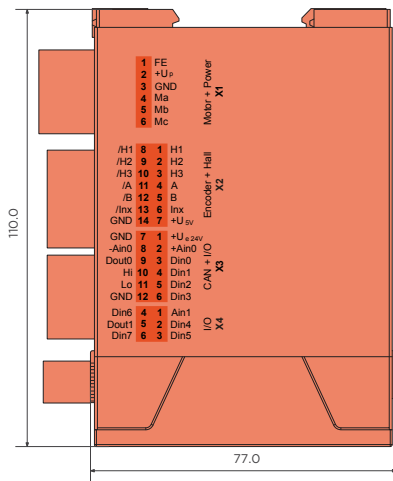

CANopen

Values	Unit
Power	
1 Electronic supply voltage U _e	VDC 9..30
2 Power supply voltage U _p	VDC 9..60
3 Max. output current	A 50
4 Continuous output current @ U _p =24VDC	A 10
5 Continuous output current @ U _p =48VDC	A 8.5
6 Output voltage	Up to 100%
Motor types	
7 DC motors	yes
8 BLDC motors	yes
9 Stepper motors	no
Mechanical	
10 Size LxWxH	mm 110 x 22.5 x 77
CAN bus	
11 Protocol	DS301
12 Device profile	DS402
13 Galvanically isolated	no
Incremental encoder	
14 Input voltage (24VDC tolerant)	V 0..5
15 Signal type	differential, open collector, single ended
Hall sensors	
16 Input voltage (24VDC tolerant)	V 0..5
17 Signal type	differential, open collector, single ended
Digital input	
18 Number	8 (Din0..7)
Digital output	
19 Number	2 (Dout0..1)
20 Continuous output current	A 1.5 (Load: resistive, inductive)
Analog inputs	
21 Number	2 (Ain0..1)
22 Signal type - Ain0	+/- 10 VDC, 12 Bit, differential
23 Signal type - Ain1	+/- 10 VDC, 12 Bit, single ended
Environment	
24 Operating temperature	°C -40...+70

Connection

X1 Motor		
1	FE	Functional earth
2	+Up	Power supply voltage
3	GND	Ground for power supply voltage
4	Ma	Motor phase A
5	Mb	Motor phase B
6	Mc	Motor phase C
X2 Hall and inc. encoder		
1	H1	Hall sensor 1
2	H2	Hall sensor 2
3	H3	Hall sensor 3
4	A	Inc. encoder, A channel
5	B	Inc. encoder, B channel
6	Inx	Inc. encoder, index channel
7	+U5V	5V output voltage for sensor supply Sensors: encoder, hall
8	/H1	Hall sensor 1 inverted
9	/H2	Hall sensor 2 inverted
10	/H3	Hall sensor 3 inverted
11	/A	Inc. encoder, A channel invert
12	/B	Inc. encoder, B channel inverted
13	/Inx	Inc. encoder, index channel inverted
14	GND	Ground for sensor supply (don't connect with system GND)
X3 I/O's and CAN		
1	+Ue24V	Electronic supply voltage
2	+Ain0	Analog input 0, positive
3	Din0	Digital input 0
4	Din1	Digital input 1
5	Din2	Digital input 2
6	Din3	Digital input 3
7	GND	Ground for electronic supply voltage
8	-Ain0	Analog input 0, negative
9	Dout0	Digital output 0
10	CAN Hi	CAN High
11	CAN Lo	CAN Low
12	CAN GND	CAN Ground
X4 I/O's		
1	Ain1	Analog input 1
2	Din4	Digital input 4
3	Din5	Digital input 5
4	Din6	Digital input 6
5	Dout1	Digital output 1
6	Din7	Digital input 7

SVTE-A-E45-EtherCAT Servo Drives

60VDC | 10A
DC motors, BLDC motors

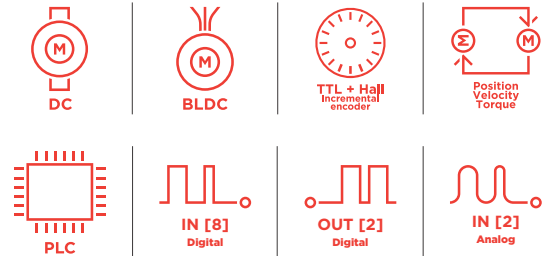
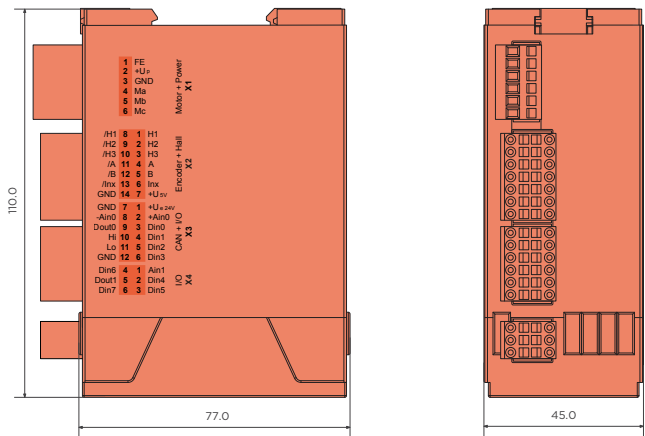

CANopen | EtherCAT

Values	Unit
Power	
1 Electronic supply voltage Ue	VDC 9..30
2 Power supply voltage Up	VDC 9..60
3 Max. output current	A 50
4 Continuous output current @ Up=24VDC	A 10
5 Continuous output current @ Up=48VDC	A 8.5
6 Output voltage	Up to 100%
Motor types	
7 DC motors	yes
8 BLDC motors	yes
9 Stepper motors	no
Mechanical	
10 Size LxWxH	mm 110 x 45 x 77
CAN bus	
11 Protocol	DS301
12 Device profile	DS402
13 Galvanically isolated	no
EtherCAT	
14 Type	EtherCAT Slave
15 Physical layer	100 Base-Tx EtherCAT
16 Max. baudrate	100 Mbit/s
17 Number of ports	2xRJ45 (In,Out)
18 Protocol	CoE (CANopen over EtherCAT)
Incremental encoder	
19 Input voltage (24VDC tolerant)	VDC 0..5
20 Signal type	differential, open collector, single ended
Hall sensors	
21 Input voltage (24VDC tolerant)	VDC 0..5
22 Signal type	differential, open collector, single ended
Digital input	
23 Number	8 (Din0..7)
Digital output	
24 Number	2 (Dout0..1)
25 Continuous output current	A 1.5 (Load: resistive, inductive)
Analog inputs	
26 Number	2 (Ain0..1)
27 Signal type - Ain0	+/- 10 VDC, 12 Bit, differential
28 Signal type - Ain1	+/- 10 VDC, 12 Bit, single ended
Environment	
29 Operating temperature	°C -25...+70

Connection

X1 Motor		
1	FE	Functional earth
2	+Up	Power supply voltage
3	GND	Ground for power supply voltage
4	Ma	Motor phase A
5	Mb	Motor phase B
6	Mc	Motor phase C
X2 Hall and inc. encoder		
1	H1	Hall sensor 1
2	H2	Hall sensor 2
3	H3	Hall sensor 3
4	A	Inc. encoder, A channel
5	B	Inc. encoder, B channel
6	Inx	Inc. encoder, index channel
7	+U5V	5V output voltage for sensor supply Sensors: encoder, hall
8	/H1	Hall sensor 1 inverted
9	/H2	Hall sensor 2 inverted
10	/H3	Hall sensor 3 inverted
11	/A	Inc. encoder, A channel invert
12	/B	Inc. encoder, B channel inverted
13	/Inx	Inc. encoder, index channel inverted
14	GND	Ground for sensor supply (don't connect with system GND)
X3 I/O's and CAN		
1	+Ue24V	Electronic supply voltage
2	+Ain0	Analog input 0, positive
3	Din0	Digital input 0
4	Din1	Digital input 1
5	Din2	Digital input 2
6	Din3	Digital input 3
7	GND	Ground for electronic supply voltage
8	-Ain0	Analog input 0, negative
9	Dout0	Digital output 0
10	CAN Hi	CAN High
11	CAN Lo	CAN Low
12	CAN GND	CAN Ground
X4 I/O's		
1	Ain1	Analog input 1
2	Din4	Digital input 4
3	Din5	Digital input 5
4	Din6	Digital input 6
5	Dout1	Digital output 1
6	Din7	Digital input 7
X5 EtherCAT - In port		
X6 EtherCAT - Out port		

SVTE-A-E45-Profinet Servo Drives

60VDC | 10A
DC motors, BLDC motors

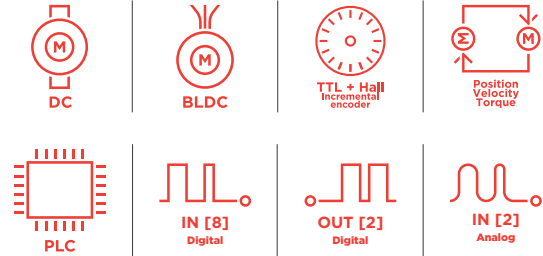
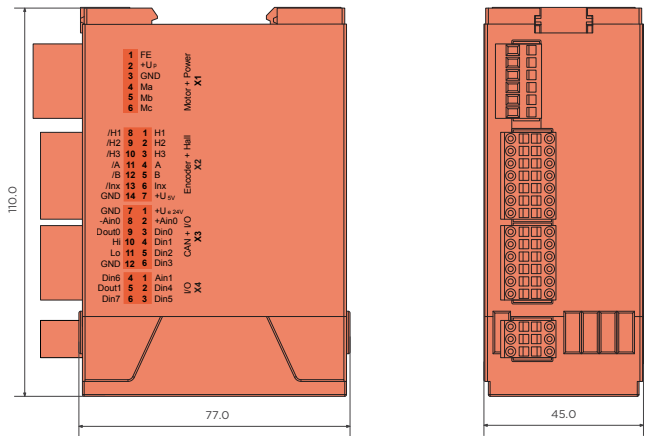

CANopen | PROFIBUS NET

Values	Unit
Power	
1 Electronic supply voltage Ue	VDC 9..30
2 Power supply voltage Up	VDC 9..60
3 Max. output current	A 50
4 Continuous output current @ Up=24VDC	A 10
5 Continuous output current @ Up=48VDC	A 8.5
6 Output voltage	Up to 100%
Motor types	
7 DC motors	yes
8 BLDC motors	yes
9 Stepper motors	no
Mechanical	
10 Size LxWxH	mm 110 x 45 x 77
CAN bus	
11 Protocol	DS301
12 Device profile	DS402
13 Galvanically isolated	no
Profinet	
14 Type	Slave
15 Physical layer	100 Base-Tx
16 Max. baudrate	100 Mbit/s
17 Number of ports	2xRJ45 (PORT1,PORT2)
Incremental encoder	
18 Input voltage (24VDC tolerant)	VDC 0..5
19 Signal type	differential, open collector, single ended
Hall sensors	
20 Input voltage (24VDC tolerant)	VDC 0..5
21 Signal type	differential, open collector, single ended
Digital input	
22 Number	8 (Din0..7)
Digital output	
23 Number	2 (Dout0..1)
24 Continuous output current	A 1.5 (Load: resistive, inductive)
Analog inputs	
25 Number	2 (Ain0..1)
26 Signal type - Ain0	+/- 10 Vdc, 12 Bit, differential
27 Signal type - Ain1	+/- 10 Vdc, 12 Bit, single ended
Environment	
28 Operating temperature	°C -25...+40

Connection

X1 Motor		
1	FE	Functional earth
2	+Up	Power supply voltage
3	GND	Ground for power supply voltage
4	Ma	Motor phase A
5	Mb	Motor phase B
6	Mc	Motor phase C
X2 Hall and inc. encoder		
1	H1	Hall sensor 1
2	H2	Hall sensor 2
3	H3	Hall sensor 3
4	A	Inc. encoder, A channel
5	B	Inc. encoder, B channel
6	Inx	Inc. encoder, index channel
7	+U5V	5V output voltage for sensor supply Sensors: encoder, hall
8	/H1	Hall sensor 1 inverted
9	/H2	Hall sensor 2 inverted
10	/H3	Hall sensor 3 inverted
11	/A	Inc. encoder, A channel invert
12	/B	Inc. encoder, B channel inverted
13	/Inx	Inc. encoder, index channel inverted
14	GND	Ground for sensor supply (don't connect with system GND)
X3 I/O's and CAN		
1	+Ue24V	Electronic supply voltage
2	+Ain0	Analog input 0, positive
3	Din0	Digital input 0
4	Din1	Digital input 1
5	Din2	Digital input 2
6	Din3	Digital input 3
7	GND	Ground for electronic supply voltage
8	-Ain0	Analog input 0, negative
9	Dout0	Digital output 0
10	CAN Hi	CAN High
11	CAN Lo	CAN Low
12	CAN GND	CAN Ground
X4 I/O's		
1	Ain1	Analog input 1
2	Din4	Digital input 4
3	Din5	Digital input 5
4	Din6	Digital input 6
5	Dout1	Digital output 1
6	Din7	Digital input 7
X5 Profinet - PORT1		
X6 Profinet - PORT2		

SVTE-A-E47-CanOpen Servo Drives

60VDC | 10A
DC motors, BLDC motors

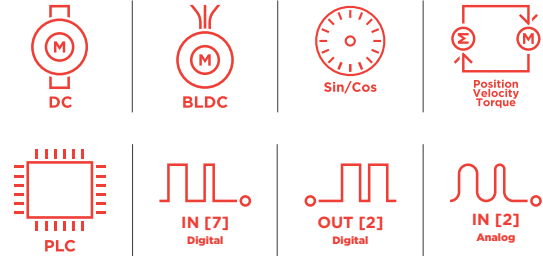
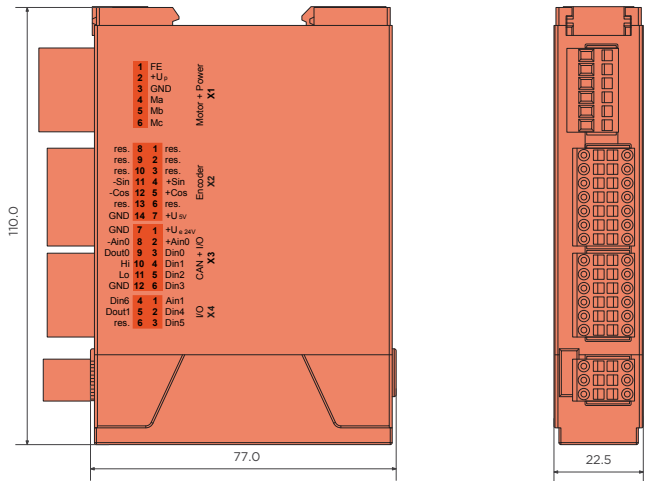

CANopen

Values	Unit
Power	
1 Electronic supply voltage U_e	VDC 9..30
2 Power supply voltage U_p	VDC 9..60
3 Max. output current	A 50
4 Continuous output current @ $U_p=24VDC$	A 10
5 Continuous output current @ $U_p=48VDC$	A 8.5
6 Output voltage	Up to 100%
Motor types	
7 DC motors	yes
8 BLDC motors	yes
9 Stepper motors	no
Mechanical	
10 Size LxWxH	mm 110 x 22.5 x 77
CAN bus	
11 Protocol	DS301
12 Device profile	DS402
13 Galvanically isolated	no
Encoder	
14 Input voltage	VDC 1 V peak-peak, differential
15 Signal type	sin / cos, analog, differential
16 Resolution	13 bit per sine period
Digital input	
17 Number	7 (Din0..6)
Digital output	
18 Number	2 (Dout0..1)
19 Continuous output current	A 1.5 (Load: resistive, inductive)
Analog inputs	
20 Number	2 (Ain0..1)
21 Signal type - Ain0	+/- 10 Vdc, 12 Bit, differential
22 Signal type - Ain1	+/- 10 Vdc, 12 Bit, single ended
Environment	
23 Operating temperature	°C -40...+70

Connection

X1 Motor		
1	FE	Functional earth
2	+Up	Power supply voltage
3	GND	Ground for power supply voltage
4	Ma	Motor phase A
5	Mb	Motor phase B
6	Mc	Motor phase C
X2 Encoder sin/cos		
1	res.	Reserved
2	res.	Reserved
3	res.	Reserved
4	+Sin	Sine + signal
5	+Cos	Cosine + signal
6	res.	Reserved
7	+U5V	5V output voltage for sensor supply Sensors: encoder
8	res.	Reserved
9	res.	Reserved
10	res.	Reserved
11	-Sin	Sine - signal
12	-Cos	Cosine - signal
13	res.	Reserved
14	GND	Ground for sensor supply Notice: don't connect with system GND
X3 I/O's and CAN		
1	+Ue24V	Electronic supply voltage
2	+Ain0	Analog input 0, positive
3	Din0	Digital input 0
4	Din1	Digital input 1
5	Din2	Digital input 2
6	Din3	Digital input 3
7	GND	Ground for electronic supply voltage
8	-Ain0	Analog input 0, negative
9	Dout0	Digital output 0
10	CAN Hi	CAN High
11	CAN Lo	CAN Low
12	CAN GND	CAN Ground
X4 I/O's		
1	Ain1	Analog input 1
2	Din4	Digital input 4
3	Din5	Digital input 5
4	Din6	Digital input 6
5	Dout1	Digital output 1
6	res.	Reserved

SVTE-A-E47-EtherCAT Servo Drives

60VDC | 10A
DC motors, BLDC motors

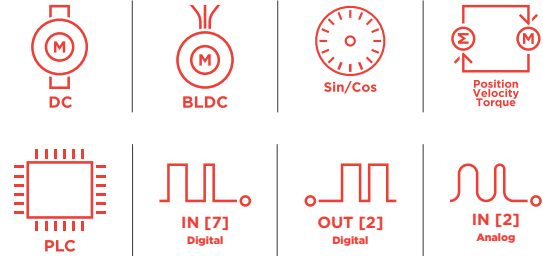
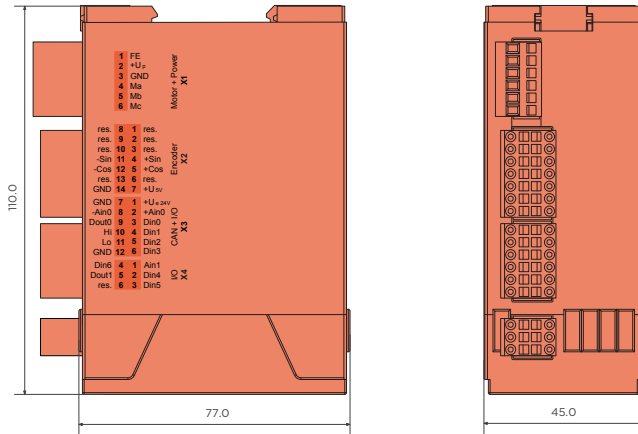

CANopen | EtherCAT

Values	Unit
Power	
1 Electronic supply voltage U _e	VDC 9..30
2 Power supply voltage U _p	VDC 9..60
3 Max. output current	A 50
4 Continuous output current @ U _p =24VDC	A 10
5 Continuous output current @ U _p =48VDC	A 8.5
6 Output voltage	Up to 100%
Motor types	
7 DC motors	yes
8 BLDC motors	yes
9 Stepper motors	no
Mechanical	
10 Size LxWxH	mm 110 x 45 x 77
CAN bus	
11 Protocol	DS301
12 Device profile	DS402
13 Galvanically isolated	no
EtherCAT	
14 Type	EtherCAT Slave
15 Physical layer	100 Base-Tx EtherCAT
16 Max. baudrate	100 Mbit/s
17 Number of ports	2xRJ45 (In,Out)
18 Protocol	CoE (CANopen over EtherCAT)
Encoder	
19 Input voltage	sin / cos
20 Signal type	1 Vdc peak-peak, differential
21 Resolution	13 bit per sine period
Digital input	
22 Number	7 (Din0..6)
Digital output	
23 Number	2 (Dout0..1)
24 Continuous output current	A 1.5 (Load: resistive, inductive)
Analog inputs	
25 Number	2 (Ain0..1)
26 Signal type - Ain0	+/- 10 Vdc, 12 Bit, differential
27 Signal type - Ain1	+/- 10 Vdc, 12 Bit, single ended
Environment	
28 Operating temperature	°C -25...+70

Connection

X1 Motor		
1	FE	Functional earth
2	+Up	Power supply voltage
3	GND	Ground for power supply voltage
4	Ma	Motor phase A
5	Mb	Motor phase B
6	Mc	Motor phase C
X2 Encoder sin/cos		
1	res.	Reserved
2	res.	Reserved
3	res.	Reserved
4	+Sin	Sine + signal
5	+Cos	Cosine + signal
6	res.	Reserved
7	+U5V	5V output voltage for sensor supply Sensors: encoder
8	res.	Reserved
9	res.	Reserved
10	res.	Reserved
11	-Sin	Sine - signal
12	-Cos	Cosine - signal
13	res.	Reserved
14	GND	Ground for sensor supply (don't connect with system GND)
X3 I/O's and CAN		
1	+Ue24V	Electronic supply voltage
2	+Ain0	Analog input 0, positive
3	Din0	Digital input 0
4	Din1	Digital input 1
5	Din2	Digital input 2
6	Din3	Digital input 3
7	GND	Ground for electronic supply voltage
8	-Ain0	Analog input 0, negative
9	Dout0	Digital output 0
10	CAN Hi	CAN High
11	CAN Lo	CAN Low
12	CAN GND	CAN Ground
X4 I/O's		
1	Ain1	Analog input 1
2	Din4	Digital input 4
3	Din5	Digital input 5
4	Din6	Digital input 6
5	Dout1	Digital output 1
6	res.	Reserved
X5 EtherCAT - PORT1		
X6 EtherCAT - PORT2		

SVTE-A-E50-CanOpen Servo Drives

60VDC | 7.5A
DC motors, BLDC motors

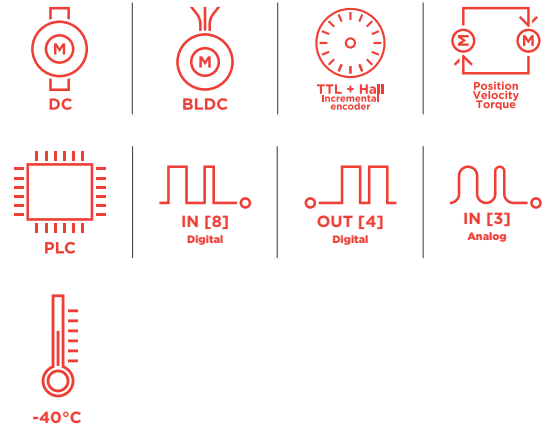
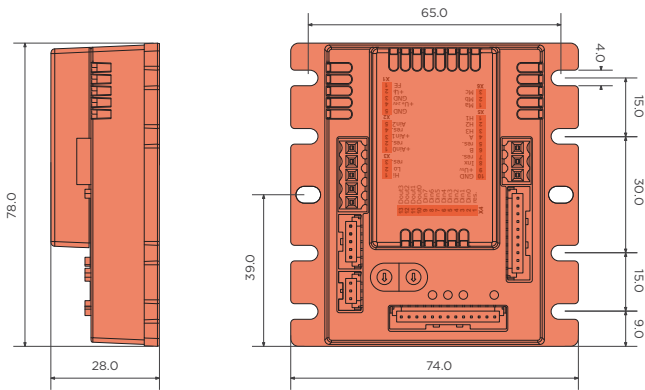

CANopen

Values	Unit
Power	
1 Electronic supply voltage U _e	VDC 9..30
2 Power supply voltage U _p	VDC 9..60
3 Max. output current	A 25
4 Continuous output current @ U _p =24VDC	A 7.5
5 Continuous output current @ U _p =60VDC	A 7
6 Output voltage	Up to 90%
Motor types	
7 DC motors	Yes
8 BLDC motors	Yes
9 Stepper motors	No
Mechanical	
10 Size LxWxH	mm 78 x 74 x 28
CAN bus	
11 Protocol	DS301
12 Device profile	DS402
13 Galvanically isolated	no
Incremental encoder	
14 Input voltage	VDC 0..5
15 Signal type	open collector, single ended
Hall sensors	
16 Input voltage	VDC 0..5
17 Signal type	open collector, single ended
Digital input	
18 Number	8 (Din0..7)
Digital output	
19 Number	4 (Dout0..3)
20 Continuous output current	A 0.3 (Load: resistive, inductive)
Analog inputs	
21 Number	3 (Ain0..2)
22 Signal type - Ain0..1	0..10V, 12 Bit, Single Ended
23 Signal type - Ain2	0..5V, 12 Bit, Single Ended
Environment	
24 Operating temperature	°C -40..+70°C

Connection

X1 Supply		
1	FE	Functional earth
2	+Up	Power supply voltage
3	GND	Ground for power supply voltage
4	+Ue24V	Electronic supply voltage
5	GND	Ground for electronic supply voltage
X2 Analog Inputs		
1	Ain0	Analog input 0
2	res.	Reserved
3	Ain1	Analog input 1
4	res.	Reserved
5	Ain2	Analog Input 2 (5V)
X3 CAN bus		
1	CAN Hi	CAN High
2	CAN Lo	CAN Low
3	res.	Reserved
X4 Digital inputs/outputs		
1	res.	Reserved
2	Din0	Digital input 0
3	Din1	Digital input 1
4	Din2	Digital input 2
5	Din3	Digital input 3
6	Din4	Digital input 4
7	Din5	Digital input 5
8	Din6	Digital input 6
9	Din7	Digital input 7
10	Dout0	Digital output 0
11	Dout1	Digital output 1
12	Dout2	Digital output 2
13	Dout3	Digital output 3
X5 Hall and inc. encoder		
1	H1	Hall sensor 1
2	H2	Hall sensor 2
3	H3	Hall sensor 3
4	A	Inc. encoder, A channel
5	res.	Reserved
6	B	Inc. encoder, B channel
7	res.	Reserved
8	Inx	Inc. encoder, index channel
9	+U5V	5V output voltage for sensor supply
10	GND	Ground for sensor supply (don't connect with system GND)
X6 Motor		
1	Ma	Motor phase A
2	Mb	Motor phase B
3	Mc	Motor phase C

SVTE-A-E55-CanOpen Servo Drives

60VDC | 10A
DC motors, BLDC motors

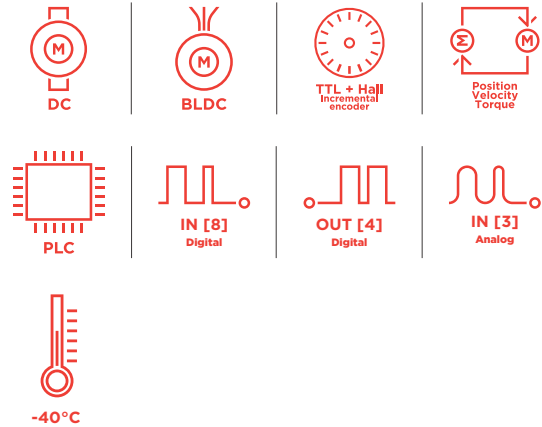
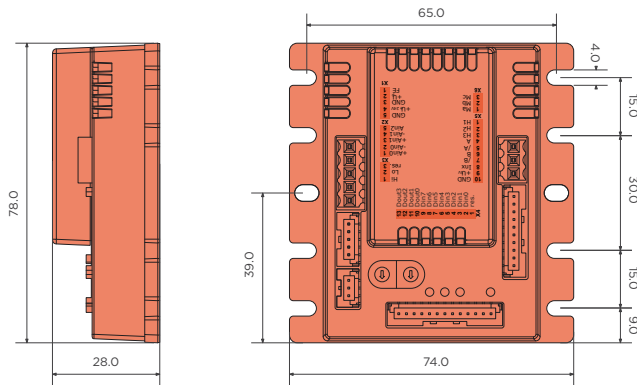

CANopen

Values	Unit
Power	
1 Electronic supply voltage Ue	VDC 9..30
2 Power supply voltage Up	VDC 9..60
3 Max. output current	A 50
4 Continuous output current @ Up=24VDC	A 10
5 Continuous output current @ Up=48VDC	A 8.5
6 Output voltage	Up to 100%
Motor types	
7 DC motors	yes
8 BLDC motors	yes
9 Stepper motors	no
Mechanical	
10 Size LxWxH	mm 78 x 74 x 28
CAN bus	
11 Protocol	DS301
12 Device profile	DS402
13 Galvanically isolated	no
Incremental encoder	
14 Input voltage (24VDC tolerant)	VDC 0..5
15 Signal type	differential, open collector, single ended, 2,5 kOhm input impedance
Hall sensor	
16 Input voltage	VDC 0..5
17 Signal type	open collector, single ended, 5VDC pull up intern 920 Ohm
Digital input	
18 Number	8 (Din0..7)
Digital output	
19 Number	4 (Dout0..3)
20 Continuous output current	A 0.3 (Load: resistive, inductive)
Analog inputs	
21 Number	3 (Ain0..2)
22 Signal type - Ain0..1	+/- 10VDC, 12 Bit, differential, 200 kOhm input impedance
23 Signal type - Ain2	0..5 VDC, 12 Bit, single ended, 5VDC pull up intern 1,5 kOhm
Environment	
24 Operating temperature	°C -40...+70

Connection

X1 Supply		
1	FE	Functional earth
2	+Up	Power supply voltage
3	GND	Ground for power supply voltage
4	+Ue24V	Electronic supply voltage
5	GND	Ground for electronic supply voltage
X2 Analog Inputs		
1	+Ain0	Analog input 0, positive
2	-Ain0	Analog input 0, negative
3	+Ain1	Analog input 1, positive
4	-Ain1	Analog input 1, negative
5	Ain2	Analog Input 2 (5V)
X3 CAN bus		
1	CAN Hi	CAN High
2	CAN Lo	CAN Low
3	res.	Reserved
X4 Digital inputs/outputs		
1	res.	Reserved
2	Din0	Digital input 0
3	Din1	Digital input 1
4	Din2	Digital input 2
5	Din3	Digital input 3
6	Din4	Digital input 4
7	Din5	Digital input 5
8	Din6	Digital input 6
9	Din7	Digital input 7
10	Dout0	Digital output 0
11	Dout1	Digital output 1
12	Dout2	Digital output 2
13	Dout3	Digital output 3
X5 Hall and inc. encoder		
1	H1	Hall sensor 1
2	H2	Hall sensor 2
3	H3	Hall sensor 3
4	A	Inc. encoder, A channel
5	/A	Inc. encoder, A channel invert
6	B	Inc. encoder, B channel
7	/B	Inc. encoder, B channel inverted
8	Inx	Inc. encoder, index channel
9	+U5V	5V output voltage for sensor supply
10	GND	Ground for sensor supply (don't connect with system GND)
X6 Motor		
1	Ma	Motor phase A
2	Mb	Motor phase B
3	Mc	Motor phase C

SVTE-A-E55-EtherCAT Servo Drives

60VDC | 8A
DC motors, BLDC motors

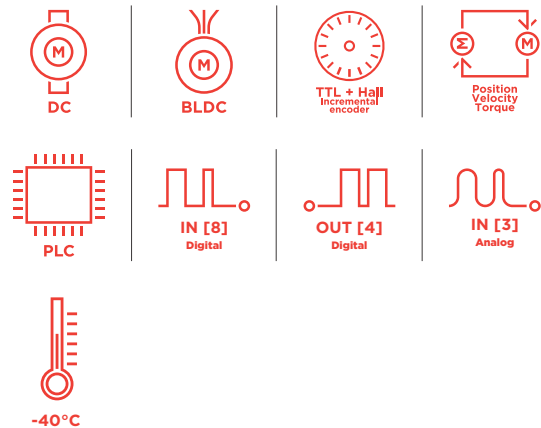
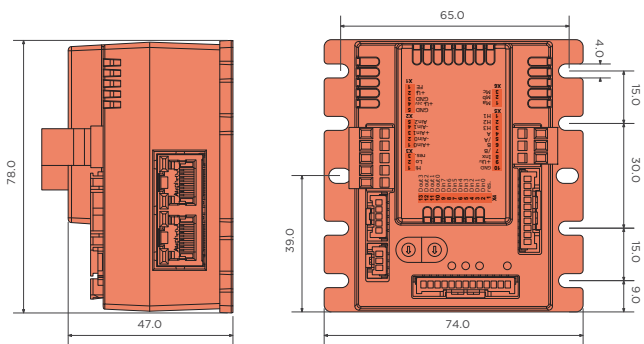

CANopen | EtherCAT

Values	Unit
Power	
1 Electronic supply voltage U _e	VDC 9..30
2 Power supply voltage U _p	VDC 9..60
3 Max. output current	A 50
4 Continuous output current	A 8
5 Output voltage	Up to 100%
Motor types	
6 DC motors	yes
7 BLDC motors	yes
8 Stepper motors	no
Mechanical	
9 Size LxWxH	mm 78x74x47
CAN bus	
10 Protocol	DS301
11 Device profile	DS402
12 Galvanically isolated	no
EtherCAT	
13 Type	EtherCAT Slave
14 Physical layer	100 Base-Tx EtherCAT
15 Max. baudrate	100 Mbit/s
16 Number of ports	2xRJ45 (In,Out)
17 Protocol	CoE (CANopen over EtherCAT)
Incremental encoder	
18 Input voltage (24VDC tolerant)	0..5
19 Signal type	differential, open collector, single ended
Hall sensors	
20 Input voltage	0..5
21 Signal type	open collector, single ended
Digital input	
22 Number	8 (Din0..7)
Digital output	
23 Number	4 (Dout0..3)
24 Continuous output current	A 0.3 (Load: resistive, inductive)
Analog inputs	
25 Number	3 (Ain0..2)
26 Signal type - Ain0..1	+/- 10 VDC, 12 Bit, differential
27 Signal type - Ain2	0..5VDC, 12 Bit, single ended
Environment	
28 Operating temperature	°C -40...+70

Connection

X1 Supply		
1	FE	Functional earth
2	+Up	Power supply voltage
3	GND	Ground for power supply voltage
4	+Ue24V	Electronic supply voltage
5	GND	Ground for electronic supply voltage
X2 Analog Inputs		
1	+Ain0	Analog input 0, positive
2	-Ain0	Analog input 0, negative
3	+Ain1	Analog input 1, positive
4	-Ain1	Analog input 1, negative
5	Ain2	Analog Input 2 (5V)
X3 CAN bus		
1	CAN Hi	CAN High
2	CAN Lo	CAN Low
3	res.	Reserved
X4 Digital inputs/outputs		
1	res.	Reserved
2	Din0	Digital input 0
3	Din1	Digital input 1
4	Din2	Digital input 2
5	Din3	Digital input 3
6	Din4	Digital input 4
7	Din5	Digital input 5
8	Din6	Digital input 6
9	Din7	Digital input 7
10	Dout0	Digital output 0
11	Dout1	Digital output 1
12	Dout2	Digital output 2
13	Dout3	Digital output 3
X5 Hall and inc. encoder		
1	H1	Hall sensor 1
2	H2	Hall sensor 2
3	H3	Hall sensor 3
4	A	Inc. encoder, A channel
5	/A	Inc. encoder, A channel invert
6	B	Inc. encoder, B channel
7	/B	Inc. encoder, B channel inverted
8	Inx	Inc. encoder, index channel
9	+U5V	5V output voltage for sensor supply
10	GND	Ground for sensor supply (don't connect with system GND)
X6 Motor		
1	Ma	Motor phase A
2	Mb	Motor phase B
3	Mc	Motor phase C
X7 EtherCAT - In port		
X8 EtherCAT - Out port		

SVTE-A-E55-Profinet Servo Drives

60VDC | 9A
DC motors, BLDC motors

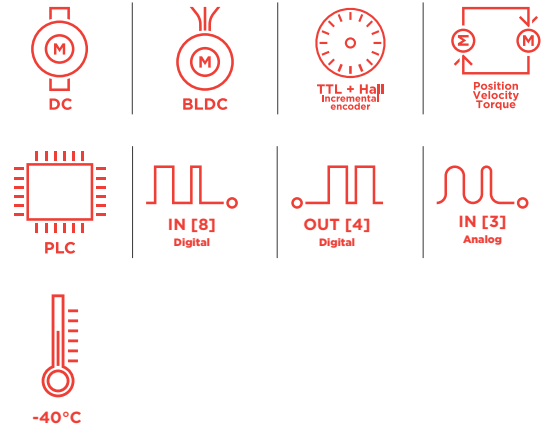
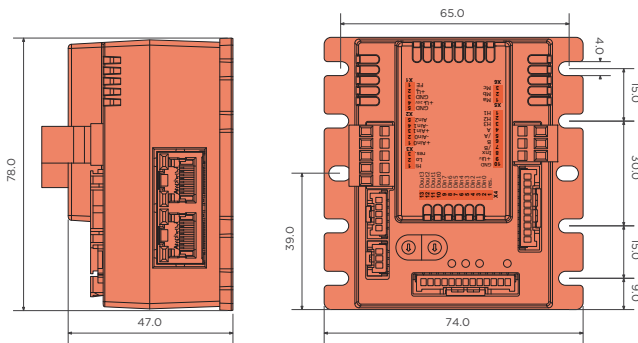

CANopen | PROFIBUS NET

Values	Unit
Power	
1 Electronic supply voltage Ue	VDC 9..30
2 Power supply voltage Up	VDC 9..60
3 Max. output current	A 50
4 Continuous output current @ Up=24VDC	A 9
5 Continuous output current @ Up=48VDC	A 8
6 Output voltage	Up to 100%
Motor types	
7 DC motors	yes
8 BLDC motors	yes
9 Stepper motors	no
Mechanical	
10 Size LxWxH	mm 78 x 74 x 47
CAN bus	
11 Protocol	DS301
12 Device profile	DS402
13 Galvanically isolated	no
Profinet	
14 Type	Slave
15 Physical layer	100 Base-Tx
16 Max. baudrate	100 Mbit/s
17 Number of ports	2xRJ45 (PORT1, PORT2)
Incremental encoder	
18 Input voltage (24VDC tolerant)	VDC 0..5
19 Signal type	differential, open collector, single ended, 2.5 kOhm input impedance
Hall sensors	
20 Input voltage	VDC 0..5
21 Signal type	open collector, single ended, 5VDC pull up intern 920 Ohm
Digital input	
22 Number	8 (Din0..7)
Digital output	
23 Number	4 (Dout0..3)
24 Continuous output current	A 0.3 (Load: resistive, inductive)
Analog inputs	
25 Number	3 (Ain0..2)
26 Signal type - Ain0...1	+/- 10 VDC, 12 Bit, differential, 20 kOhm input impedance
27 Signal type - Ain2	0..5 VDC, 12 Bit, single ended, 5VDC pull up intern 1.5 kOhm
Environment	
28 Operating temperature	°C -40...+70

Connection

X1 Supply		
1	FE	Functional earth
2	+Up	Power supply voltage
3	GND	Ground for power supply voltage
4	+Ue24V	Electronic supply voltage
5	GND	Ground for electronic supply voltage
X2 Analog Inputs		
1	+Ain0	Analog input 0, positive
2	-Ain0	Analog input 0, negative
3	+Ain1	Analog input 1, positive
4	-Ain1	Analog input 1, negative
5	Ain2	Analog Input 2 (5V)
X3 CAN bus		
1	CAN Hi	CAN High
2	CAN Lo	CAN Low
3	res.	Reserved
X4 Digital inputs/outputs		
1	res.	Reserved
2	Din0	Digital input 0
3	Din1	Digital input 1
4	Din2	Digital input 2
5	Din3	Digital input 3
6	Din4	Digital input 4
7	Din5	Digital input 5
8	Din6	Digital input 6
9	Din7	Digital input 7
10	Dout0	Digital output 0
11	Dout1	Digital output 1
12	Dout2	Digital output 2
13	Dout3	Digital output 3
X5 Hall and inc. encoder		
1	H1	Hall sensor 1
2	H2	Hall sensor 2
3	H3	Hall sensor 3
4	A	Inc. encoder, A channel
5	/A	Inc. encoder, A channel invert
6	B	Inc. encoder, B channel
7	/B	Inc. encoder, B channel inverted
8	Inx	Inc. encoder, index channel
9	+U5V	5V output voltage for sensor supply
10	GND	Ground for sensor supply (don't connect with system GND)
X6 Motor		
1	Ma	Motor phase A
2	Mb	Motor phase B
3	Mc	Motor phase C
X7 Profinet - In port		
X8 Profinet - Out port		

SVTE-A-E57-CanOpen Servo Drives

60VDC | 10A
DC motors, BLDC motors

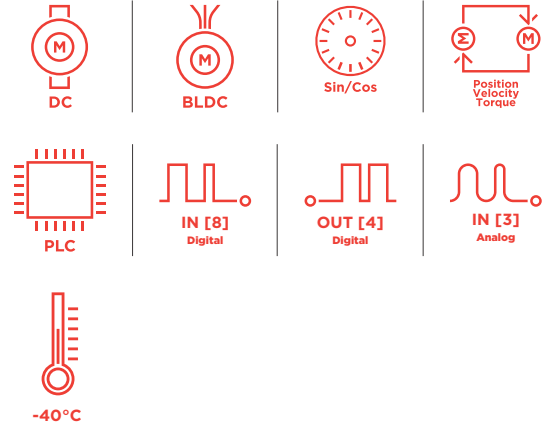
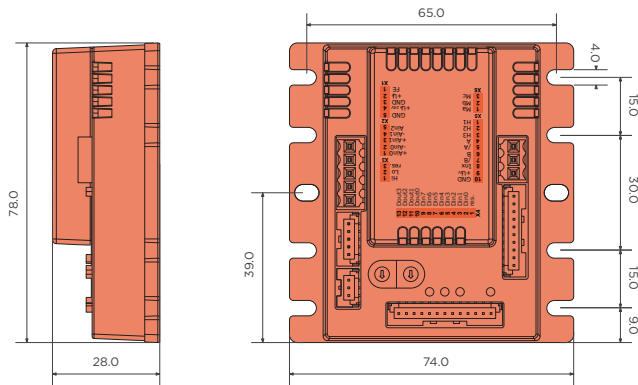

CANopen

Values	Unit
Power	
1 Electronic supply voltage Ue	VDC 9..30
2 Power supply voltage Up	VDC 9..60
3 Max. output current	A 50
4 Continuous output current @ Up=24VDC	A 10
5 Output voltage	Up to 100%
Motor types	
6 DC motors	yes
7 BLDC motors	yes
8 Stepper motors	no
Mechanical	
9 Size LxWxH	mm 78 x 74 x 28
CAN bus	
10 Protocol	DS301
11 Device profile	DS402
12 Galvanically isolated	no
Encoder	
13 Input voltage	VDC 1 VDC peak-peak, differential
14 Signal type	sin / cos, analog, differential, 1085 kOhm input impedance
15 Resolution	13 bit per sine period
Digital input	
16 Number	8 (Din0..7)
Digital output	
17 Number	4 (Dout0..3)
18 Continuous output current	A 0.3 (Load: resistive, inductive)
Analog inputs	
19 Number	3 (Ain0..2)
20 Signal type - Ain0..1	+/- 10VDC, 12 Bit, differential, 200 kOhm input impedance
21 Signal type - Ain2	0..5 VDC, 12 Bit, single ended, 5VDC pull up intern 1.5 kOhm
Environment	
21 Operating temperature	°C -40...+70

Connection

X1 Supply		
1	FE	Functional earth
2	+Up	Power supply voltage
3	GND	Ground for power supply voltage
4	+Ue24V	Electronic supply voltage
5	GND	Ground for electronic supply voltage
X2 Analog Inputs		
1	+Ain0	Analog input 0, positive
2	-Ain0	Analog input 0, negative
3	+Ain1	Analog input 1, positive
4	-Ain1	Analog input 1, negative
5	Ain2	Analog Input 2 (5V)
X3 CAN bus		
1	CAN Hi	CAN High
2	CAN Lo	CAN Low
3	res.	Reserved
X4 Digital inputs/outputs		
1	res.	Reserved
2	Din0	Digital input 0
3	Din1	Digital input 1
4	Din2	Digital input 2
5	Din3	Digital input 3
6	Din4	Digital input 4
7	Din5	Digital input 5
8	Din6	Digital input 6
9	Din7	Digital input 7
10	Dout0	Digital output 0
11	Dout1	Digital output 1
12	Dout2	Digital output 2
13	Dout3	Digital output 3
X5 Encoder SinCos		
1	res.	Reserved
2	res.	Reserved
3	res.	Reserved
4	+Sin	Encoder, plus sine signal
5	-Sin	Encoder, minus sine signal
6	+Cos	Encoder, plus cosine signal
7	-Cos	Encoder, minus cosine signal
8	res.	Reserved
9	+U5V	5V output voltage for sensor supply
10	GND	Ground for sensor supply (don't connect with system GND)
X6 Motor		
1	Ma	Motor phase A
2	Mb	Motor phase B
3	Mc	Motor phase C

SVTE-A-E50-HC-CanOpen Servo Drives

60VDC | 14.5A
DC motors, BLDC motors

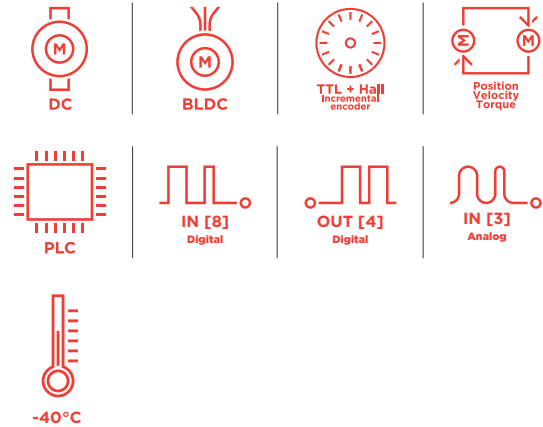
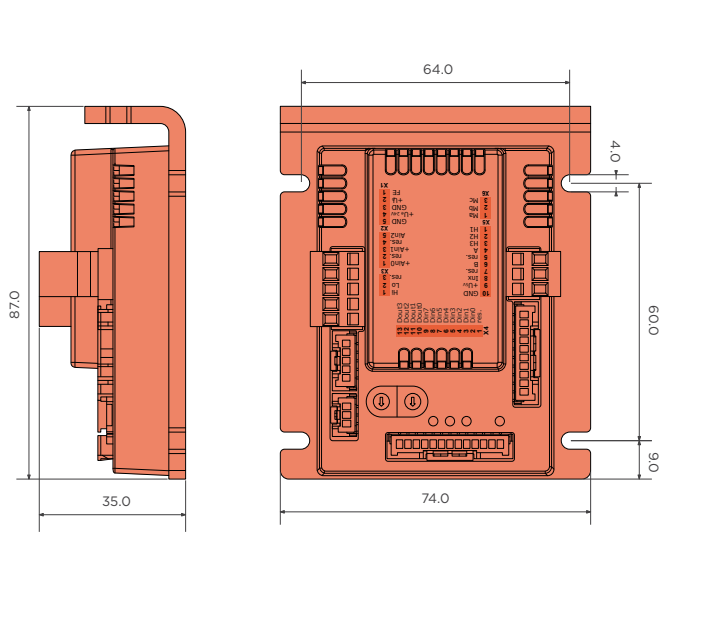

CANopen

Values	Unit
Power	
1 Electronic supply voltage Ue	VDC 9..30
2 Power supply voltage Up	VDC 9..60
3 Max. output current	A 25
4 Continuous output current	A 14.5
5 Continuous output current @ Up=24VDC	A 9.5
6 Continuous output current @ Up=60VDC	A 9
7 Output voltage	Up to 90%
Motor types	
8 DC motors	Yes
9 BLDC motors	Yes
10 Stepper motors	No
Mechanical	
11 Size LxWxH	mm 87 x 74 x 28
CAN bus	
12 Protocol	DS301
13 Device profile	DS402
14 Galvanically isolated	no
Incremental encoder	
15 Input voltage	VDC 0..5
16 Signal type	open collector, single ended
Hall sensors	
17 Input voltage	VDC 0..5
18 Signal type	open collector, single ended
Digital input	
19 Number	8 (Din0..7)
Digital output	
20 Number	4 (Dout0..3)
21 Continuous output current	A 0.3 (Load: resistive, inductive)
Analog inputs	
22 Number	3 (Ain0..2)
23 Signal type - Ain0..1	0..10V, 12 Bit, Single Ended
24 Signal type - Ain2	0..5V, 12 Bit, Single Ended
Environment	
25 Operating temperature	°C -40..+70°C

Connection

X1 Supply		
1	FE	Functional earth
2	+Up	Power supply voltage
3	GND	Ground for power supply voltage
4	+Ue24V	Electronic supply voltage
5	GND	Ground for electronic supply voltage
X2 Analog Inputs		
1	Ain0	Analog input 0
2	res.	Reserved
3	Ain1	Analog input 1
4	res.	Reserved
5	Ain2	Analog Input 2 (5V)
X3 CAN bus		
1	CAN Hi	CAN High
2	CAN Lo	CAN Low
3	res.	Reserved
X4 Digital inputs/outputs		
1	res.	Reserved
2	Din0	Digital input 0
3	Din1	Digital input 1
4	Din2	Digital input 2
5	Din3	Digital input 3
6	Din4	Digital input 4
7	Din5	Digital input 5
8	Din6	Digital input 6
9	Din7	Digital input 7
10	Dout0	Digital output 0
11	Dout1	Digital output 1
12	Dout2	Digital output 2
13	Dout3	Digital output 3
X5 Hall and inc. encoder		
1	H1	Hall sensor 1
2	H2	Hall sensor 2
3	H3	Hall sensor 3
4	A	Inc. encoder, A channel
5	res.	Reserved
6	B	Inc. encoder, B channel
7	res.	Reserved
8	Inx	Inc. encoder, index channel
9	+U5V	5V output voltage for sensor supply
10	GND	Ground for sensor supply (don't connect with system GND)
X6 Motor		
1	Ma	Motor phase A
2	Mb	Motor phase B
3	Mc	Motor phase C

SVTE-A-E55-HC-CanOpen Servo Drives

60VDC | 14.5A
DC motors, BLDC motors

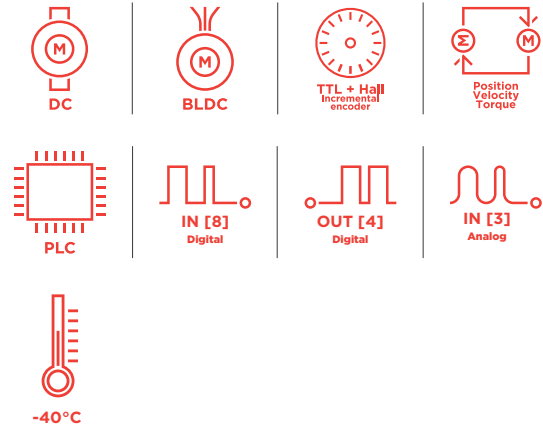
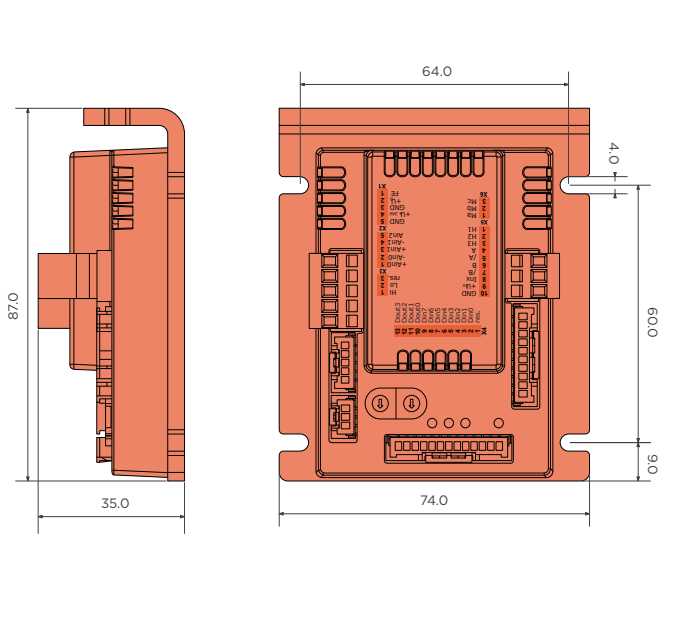

CANopen

Values	Unit
Power	
1 Electronic supply voltage Ue	VDC 9..30
2 Power supply voltage Up	VDC 9..60
3 Max. output current	A 50
4 Continuous output current	A 14.5
5 Continuous output current @ Up=24VDC	A 9.5
6 Continuous output current @ Up=60VDC	A 9
7 Output voltage	Up to 100%
Motor types	
8 DC motors	yes
9 BLDC motors	yes
10 Stepper motors	no
Mechanical	
11 Size LxWxH	mm 87 x 74 x 28
CAN bus	
12 Protocol	DS301
13 Device profile	DS402
14 Galvanically isolated	no
Incremental encoder	
15 Input voltage	VDC 0..5
16 Signal type	open collector, single ended
Hall sensors	
17 Input voltage	VDC 0..5
18 Signal type	open collector, single ended
Digital input	
19 Number	8 (Din0..7)
Digital output	
20 Number	4 (Dout0..3)
21 Continuous output current	A 0.3 (Load: resistive, inductive)
Analog inputs	
22 Number	3 (Ain0..2)
23 Signal type - Ain0..1	0..10V, 12 Bit, Single Ended
24 Signal type - Ain2	0..5V, 12 Bit, Single Ended
Environment	
24 Operating temperature	°C -40..+70°C

Connection

X1 Supply		
1	FE	Functional earth
2	+Up	Power supply voltage
3	GND	Ground for power supply voltage
4	+Ue24V	Electronic supply voltage
5	GND	Ground for electronic supply voltage
X2 Analog Inputs		
1	+Ain0	Analog input 0, positive
2	-Ain0	Analog input 0, negative
3	+Ain1	Analog input 1, positive
4	-Ain1	Analog input 1, negative
5	Ain2	Analog Input 2 (5V)
X3 CAN bus		
1	CAN Hi	CAN High
2	CAN Lo	CAN Low
3	res.	Reserved
X4 Digital inputs/outputs		
1	res.	Reserved
2	Din0	Digital input 0
3	Din1	Digital input 1
4	Din2	Digital input 2
5	Din3	Digital input 3
6	Din4	Digital input 4
7	Din5	Digital input 5
8	Din6	Digital input 6
9	Din7	Digital input 7
10	Dout0	Digital output 0
11	Dout1	Digital output 1
12	Dout2	Digital output 2
13	Dout3	Digital output 3
X5 Hall and inc. encoder		
1	H1	Hall sensor 1
2	H2	Hall sensor 2
3	H3	Hall sensor 3
4	A	Inc. encoder, A channel
5	/A	Inc. encoder, A channel invert
6	B	Inc. encoder, B channel
7	/B	Inc. encoder, B channel inverted
8	Inx	Inc. encoder, index channel
9	+U5V	5V output voltage for sensor supply
10	GND	Ground for sensor supply (don't connect with system GND)
X6 Motor		
1	Ma	Motor phase A
2	Mb	Motor phase B
3	Mc	Motor phase C

SVTE-A-E55-HC-EtherCAT Servo Drives

60VDC | 14.5A
DC motors, BLDC motors

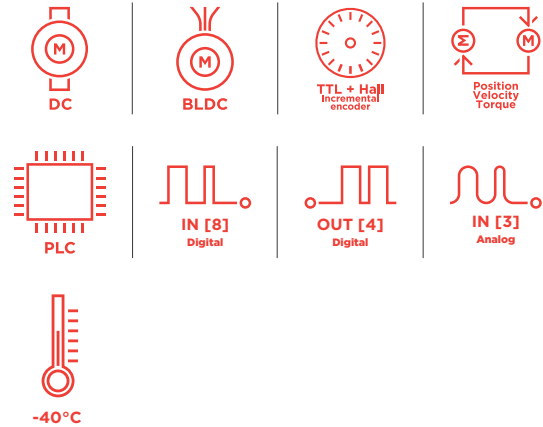
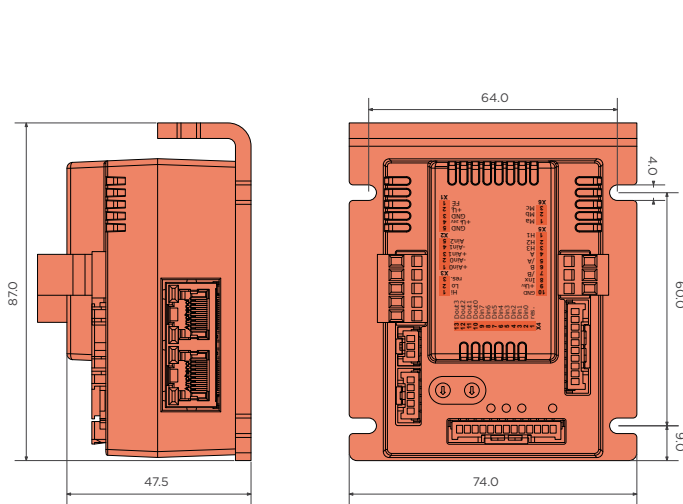

CANopen | EtherCAT

Values	Unit
Power	
1 Electronic supply voltage Ue	VDC 9..30
2 Power supply voltage Up	VDC 9..60
3 Max. output current	A 50
4 Continuous output current	A 14.5
5 Output voltage	Up to 100%
Motor types	
6 DC motors	yes
7 BLDC motors	yes
8 Stepper motors	no
Mechanical	
9 Size LxWxH	mm 87 x 74 x 47
CAN bus	
10 Protocol	DS301
11 Device profile	DS402
12 Galvanically isolated	no
EtherCAT	
13 Type	EtherCAT Slave
14 Physical layer	100 Base-Tx EtherCAT
15 Max. baudrate	100 Mbit/s
16 Number of ports	2xRJ45 (In,Out)
17 Protocol	CoE (CANopen over EtherCAT)
Incremental encoder	
18 Input voltage	VDC 0..5
19 Signal type	differential, open collector, single ended
Hall sensors	
20 Input voltage	VDC 0..5
21 Signal type	open collector, single ended
Digital input	
22 Number	8 (Din0..7)
Digital output	
23 Number	4 (Dout0..3)
24 Continuous output current	A 0.3 (Load: resistive, inductive)
Analog inputs	
25 Number	3 (Ain0..2)
26 Signal type - Ain0..1	+/-10V, 12 Bit, differential
27 Signal type - Ain2	0..5V, 12 Bit, single ended
Environment	
28 Operating temperature	°C -40..+70°C

Connection

X1 Supply		
1	FE	Functional earth
2	+Up	Power supply voltage
3	GND	Ground for power supply voltage
4	+Ue24V	Electronic supply voltage
5	GND	Ground for electronic supply voltage
X2 Analog Inputs		
1	+Ain0	Analog input 0, positive
2	-Ain0	Analog input 0, negative
3	+Ain1	Analog input 1, positive
4	-Ain1	Analog input 1, negative
5	Ain2	Analog Input 2 (5V)
X3 CAN bus		
1	CAN Hi	CAN High
2	CAN Lo	CAN Low
3	res.	Reserved
X4 Digital inputs/outputs		
1	res.	Reserved
2	Din0	Digital input 0
3	Din1	Digital input 1
4	Din2	Digital input 2
5	Din3	Digital input 3
6	Din4	Digital input 4
7	Din5	Digital input 5
8	Din6	Digital input 6
9	Din7	Digital input 7
10	Dout0	Digital output 0
11	Dout1	Digital output 1
12	Dout2	Digital output 2
13	Dout3	Digital output 3
X5 Hall and inc. encoder		
1	H1	Hall sensor 1
2	H2	Hall sensor 2
3	H3	Hall sensor 3
4	A	Inc. encoder, A channel
5	/A	Inc. encoder, A channel invert
6	B	Inc. encoder, B channel
7	/B	Inc. encoder, B channel inverted
8	Inx	Inc. encoder, index channel
9	+U5V	5V output voltage for sensor supply
10	GND	Ground for sensor supply (don't connect with system GND)
X6 Motor		
1	Ma	Motor phase A
2	Mb	Motor phase B
3	Mc	Motor phase C
X7 EtherCAT - In port		
X8 EtherCAT - Out port		

SVTE-A-E55-HC-Profinet Servo Drives

60VDC | 14.5A
DC motors, BLDC motors

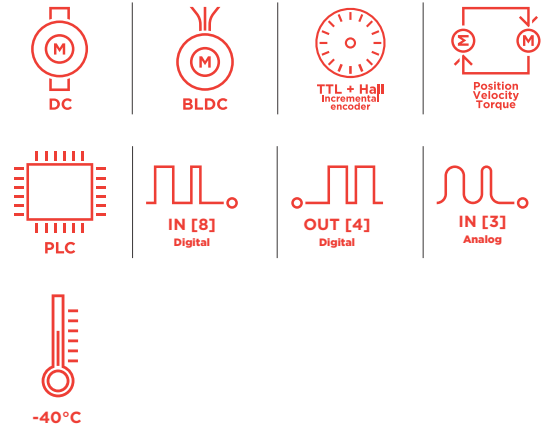
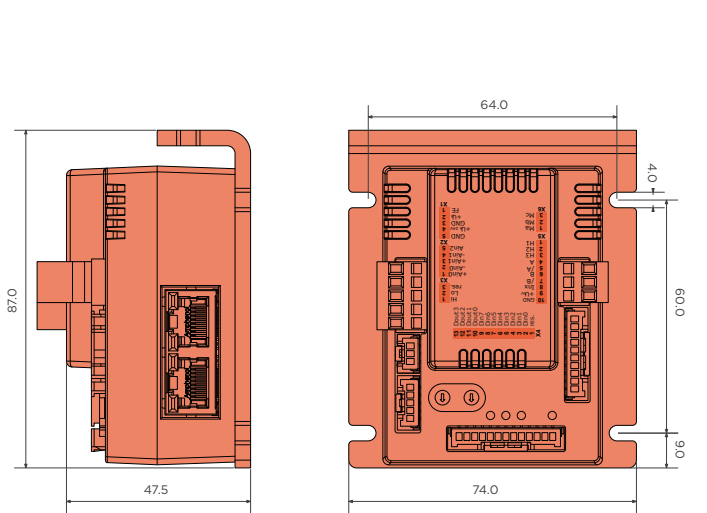

CANopen | PROFINET

Values	Unit
Power	
1 Electronic supply voltage Ue	VDC 9..30
2 Power supply voltage Up	Vdc 9..60
3 Max. output current	A 50
4 Continuous output current	A 14.5
5 Output voltage	Up to 100%
Motor types	
6 DC motors	yes
7 BLDC motors	yes
8 Stepper motors	no
Mechanical	
9 Size LxWxH	mm 78 x 74 x 47
CAN bus	
10 Protocol	DS301
11 Device profile	DS402
12 Galvanically isolated	no
Profinet	
13 Type	Slave
14 Physical layer	100 Base-Tx
15 Max. baudrate	100 Mbit/s
16 Number of ports	2xRJ45 (PORT1,PORT2)
Incremental encoder	
17 Input voltage (24VDC tolerant)	VDC 0..5
18 Signal type	differential, open collector, single ended
Hall sensors	
19 Input voltage	VDC 0.5
20 Signal type	open collector, single ended
Digital input	
21 Number	8 (Din0..7)
Digital output	
22 Number	4 (Dout0..3)
23 Continuous output current	A 0.3
Analog inputs	
24 Number	3 (Ain0..2)
25 Signal type - Ain0...1	+/- 10 V, 12 Bit, differential
26 Signal type - Ain2	0..5 V, 12 Bit, single ended
Environment	
27 Operating temperature	°C -40..+70°C

Connection

X1 Supply		
1	FE	Functional earth
2	+Up	Power supply voltage
3	GND	Ground for power supply voltage
4	+Ue24V	Electronic supply voltage
5	GND	Ground for electronic supply voltage
X2 Analog Inputs		
1	+Ain0	Analog input 0, positive
2	-Ain0	Analog input 0, negative
3	+Ain1	Analog input 1, positive
4	-Ain1	Analog input 1, negative
5	Ain2	Analog Input 2 (5V)
X3 CAN bus		
1	CAN Hi	CAN High
2	CAN Lo	CAN Low
3	res.	Reserved
X4 Digital inputs/outputs		
1	res.	Reserved
2	Din0	Digital input 0
3	Din1	Digital input 1
4	Din2	Digital input 2
5	Din3	Digital input 3
6	Din4	Digital input 4
7	Din5	Digital input 5
8	Din6	Digital input 6
9	Din7	Digital input 7
10	Dout0	Digital output 0
11	Dout1	Digital output 1
12	Dout2	Digital output 2
13	Dout3	Digital output 3
X5 Hall and inc. encoder		
1	H1	Hall sensor 1
2	H2	Hall sensor 2
3	H3	Hall sensor 3
4	A	Inc. encoder, A channel
5	/A	Inc. encoder, A channel invert
6	B	Inc. encoder, B channel
7	/B	Inc. encoder, B channel inverted
8	Inx	Inc. encoder, index channel
9	+U5V	5V output voltage for sensor supply
10	GND	Ground for sensor supply (don't connect with system GND)
X6 Motor		
1	Ma	Motor phase A
2	Mb	Motor phase B
3	Mc	Motor phase C
X7 Profinet - In port		
X8 Profinet - Out port		

SVTE-A-E60-CanOpen Servo Drives

60VDC | 5A
DC motors, BLDC motors

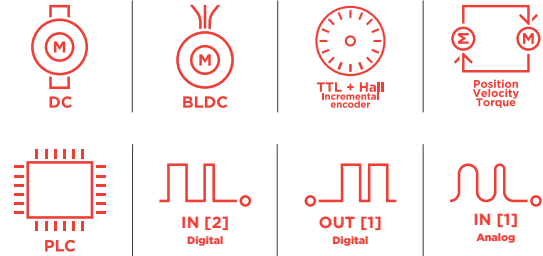
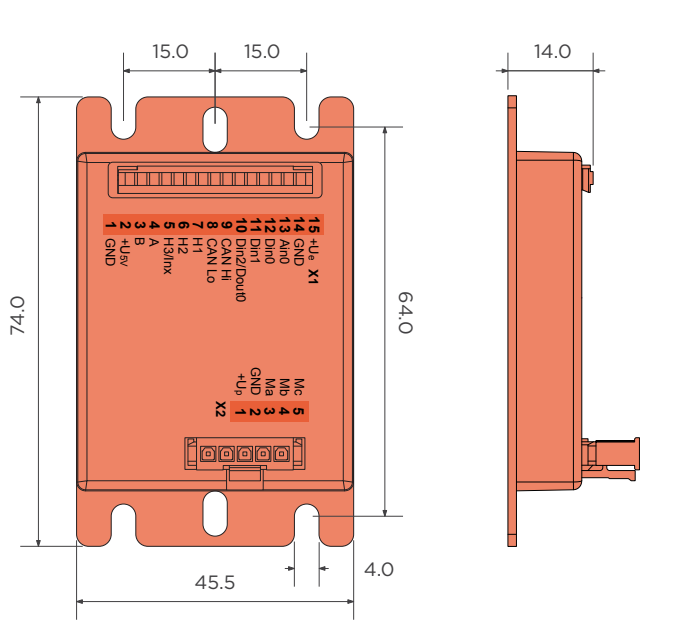

CANopen

Values	Unit
Power	
1 Electronic supply voltage Ue	VDC 9..30
2 Power supply voltage Up	VDC 9..60
3 Max. output current	A 15
4 Continuous output current @ Up=24VDC	A 5
5 Continuous output current @ Up=48VDC	A 4.3
6 Output voltage	Up to 90%
Motor types	
7 DC motors	yes
8 BLDC motors	yes
9 Stepper motors	no
Mechanical	
10 Size LxWxH	mm 74 x 45.5 x 14
CAN bus	
11 Protocol	DS301
12 Device profile	DS402
13 Galvanically isolated	no
Incremental encoder	
14 Input voltage	VDC 0..5
15 Signal type	open collector, single ended
Hall sensor	
16 Input voltage	VDC 0..5
17 Signal type	open collector, single ended
Digital input	
18 Number (+/-30VDC tolerant)	2 (Din0..1)
19 Number (0..30VDC tolerant)	1 (Din2); Din2 parallel with Dout0 (must not exceed electronic supply voltage)
Digital output	
20 Number	1 (Dout0); Dout0 parallel with Din2
21 Continuous output current	A 1.5 (Load: resistive, inductive)
Analog inputs	
22 Number	1 (Ain0)
23 Signal type	0..10 VDC, 12 Bit, single ended
Environment	
24 Operating temperature	°C -25...+70

Connection

X1 Hall, inc. encoder, I/O's and CAN		
1	GND	Ground of the auxiliary voltage (don't connect with system GND)
2	+U5V	5V output voltage for sensor supply Sensors: encoder, hall
3	B	Inc. encoder, B channel
4	A	Inc. encoder, A channel
5	H3/Inx	Hall sensor 3 / Inc. encoder, index channel
6	H2	Hall sensor 2
7	H1	Hall sensor 1
8	CAN Lo	CAN Low
9	CAN Hi	CAN High
10	Din2/Dout0	Digital input 2 / Digital output 0
11	Din1	Digital input 1
12	Din0	Digital input 0
13	Ain0	Analog input 0
14	GND	Ground for electronic supply voltage
15	+Ue	Electronic supply voltage
X2 Motor		
1	+Up	Power supply voltage
2	GND	Ground for sensor supply
3	Ma	Motor phase A
4	Mb	Motor phase B
5	Mc	Motor phase C

SVTE-A-E60-EtherCAT Servo Drives

60VDC | 5A
DC motors, BLDC motors

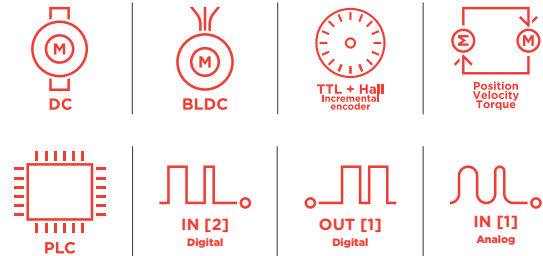
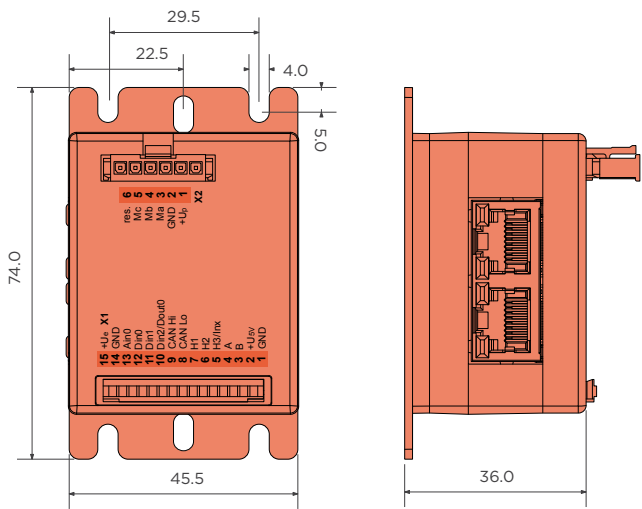

CANopen | EtherCAT

Values	Unit
Power	
1 Electronic supply voltage Ue	VDC 9..30
2 Power supply voltage Up	VDC 9..60
3 Max. output current	A 15
4 Continuous output current @ Up=24VDC	A 5
5 Continuous output current @ Up=48VDC	A 4.3
6 Output voltage	Up to 90%
Motor types	
7 DC motors	yes
8 BLDC motors	yes
9 Stepper motors	no
Mechanical	
10 Size LxWxH	mm 74 x 45.5 x 36
CAN bus	
11 Protocol	DS301
12 Device profile	DS402
13 Galvanically isolated	no
EtherCAT	
14 Type	EtherCAT Slave
15 Physical layer	100 Base-Tx EtherCAT
16 Max. baudrate	100 Mbit/s
17 Number of ports	2xRJ45 (In,Out)
18 Protocol	CoE (CANopen over EtherCAT)
Incremental encoder	
19 Input voltage	VDC 0..5
20 Signal type	open collector, single ended
Hall sensors	
21 Input voltage	VDC 0..5
22 Signal type	open collector, single ended
Digital input	
23 Number (+/-30VDC tolerant)	2 (Din0..1)
24 Number (0..30VDC tolerant)	1 (Din2); Din2 parallel with Dout0 (must not exceed electronic supply voltage)
Digital output	
25 Number	1 (Dout0); Dout0 parallel with Din2
26 Continuous output current	A 1.5 (Load: resistive, inductive)
Analog inputs	
27 Number	1 (Ain0)
28 Signal type	0..10 VDC, 12 Bit, single ended
Environment	
29 Operating temperature	°C -25...+70

Connection

X1 Hall, inc. encoder, I/O's and CAN

1	GND	Ground of the auxiliary voltage (don't connect with system GND)
2	+U5V	5V output voltage for sensor supply Sensors: encoder, hall
3	B	Inc. encoder, B channel
4	A	Inc. encoder, A channel
5	H3/Inx	Hall sensor 3 / Inc. encoder, index channel
6	H2	Hall sensor 2
7	H1	Hall sensor 1
8	CAN Lo	CAN Low
9	CAN Hi	CAN High
10	Din2/Dout0	Digital input 2 / Digital output 0
11	Din1	Digital input 1
12	Din0	Digital input 0
13	Ain0	Analog input 0
14	GND	Ground for electronic supply voltage
15	+Ue	Electronic supply voltage

X2 Motor

1	+Up	Power supply voltage
2	GND	Ground for sensor supply
3	Ma	Motor phase A
4	Mb	Motor phase B
5	Mc	Motor phase C
6	res.	Reserved

X3 EtherCAT - In port

X4 EtherCAT - Out port

SVTE-A-E65-CanOpen Servo Drives

60VDC | 5A
DC motors, BLDC motors

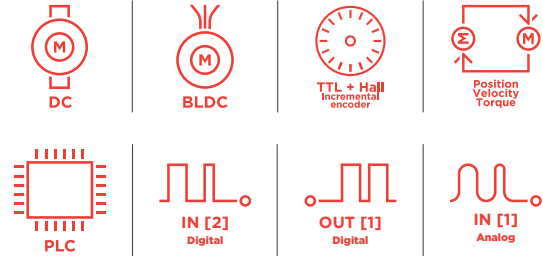
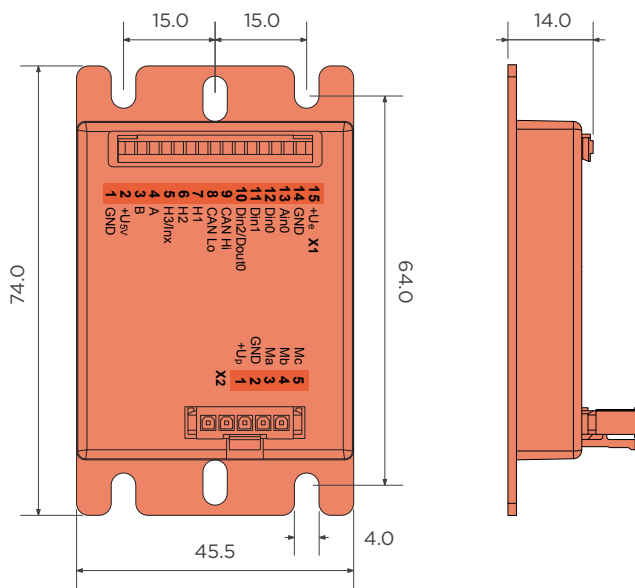

CANopen

Values	Unit
Power	
1 Electronic supply voltage Ue	VDC 9..30
2 Power supply voltage Up	VDC 9..60
3 Max. output current	A 15
4 Continuous output current @ Up=24VDC	A 5
5 Continuous output current @ Up=48VDC	A 4.3
6 Output voltage	Up to 100%
Motor types	
7 DC motors	yes
8 BLDC motors	yes
9 Stepper motors	no
Mechanical	
10 Size LxWxH	mm 74 x 45.5 x 14
CAN bus	
11 Protocol	DS301
12 Device profile	DS402
13 Galvanically isolated	no
Incremental encoder	
14 Input voltage	VDC 0..5
15 Signal type	open collector, single ended
Hall sensors	
16 Input voltage	VDC 0..5
17 Signal type	open collector, single ended
Digital input	
18 Number	2 (Din0..1)
19 Number (0..30VDC tolerant)	1 (Din2); Din2 parallel with Dout0 (must not exceed electronic supply voltage)
Digital output	
20 Number	1 (Dout0); Dout0 parallel with Din2
21 Continuous output current	A 1.5 (Load: resistive, inductive)
Analog inputs	
22 Number	1 (Ain0)
23 Signal type	+/- 10 VDC, 12 Bit, single ended
Environment	
24 Operating temperature	°C -25...+70

Connection

X1 Hall, inc. encoder, I/O's and CAN

1	GND	Ground of the auxiliary voltage (don't connect with system GND)
2	+U5V	5V output voltage for sensor supply Sensors: encoder, hall
3	B	Inc. encoder, B channel
4	A	Inc. encoder, A channel
5	H3/Inx	Hall sensor 3 / Inc. encoder, index channel
6	H2	Hall sensor 2
7	H1	Hall sensor 1
8	CAN Lo	CAN Low
9	CAN Hi	CAN High
10	Din2/Dout0	Digital input 2 / Digital output 0
11	Din1	Digital input 1
12	Din0	Digital input 0
13	Ain0	Analog input 0
14	GND	Ground for electronic supply voltage
15	+Ue	Electronic supply voltage

X2 Motor

1	+Up	Power supply voltage
2	GND	Ground for sensor supply
3	Ma	Motor phase A
4	Mb	Motor phase B
5	Mc	Motor phase C

SVTE-A-E65-EtherCAT Servo Drives

60VDC | 5A
DC motors, BLDC motors

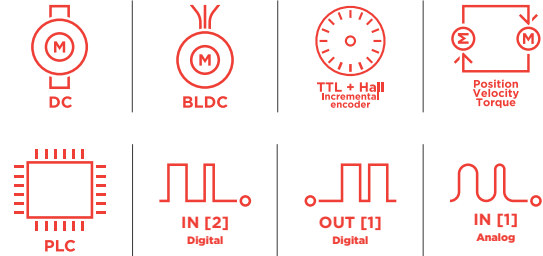
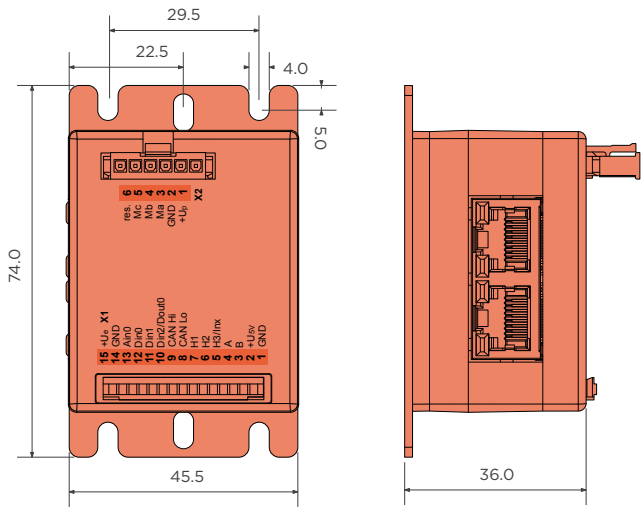

CANopen | EtherCAT

Values	Unit
Power	
1 Electronic supply voltage Ue	VDC 9..30
2 Power supply voltage Up	VDC 9..60
3 Max. output current	A 15
4 Continuous output current @ Up=24VDC	A 5
5 Continuous output current @ Up=48VDC	A 4.3
6 Output voltage	Up to 100%
Motor types	
7 DC motors	yes
8 BLDC motors	yes
9 Stepper motors	no
Mechanical	
10 Size LxWxH	mm 74 x 45.5 x 36
CAN bus	
11 Protocol	DS301
12 Device profile	DS402
13 Galvanically isolated	no
EtherCAT	
14 Type	EtherCAT Slave
15 Physical layer	100 Base-Tx EtherCAT
16 Max. baudrate	100 Mbit/s
17 Number of ports	2xRJ45 (In,Out)
18 Protocol	CoE (CANopen over EtherCAT)
Incremental encoder	
19 Input voltage	VDC 0..5
20 Signal type	open collector, single ended
Hall sensors	
21 Input voltage	VDC 0..5
22 Signal type	open collector, single ended
Digital input	
23 Number	2 (Din0..1)
24 Number (0..30VDC tolerant)	1 (Din2); Din2 parallel with Dout0 (must not exceed electronic supply voltage)
Digital output	
25 Number	1 (Dout0); Dout0 parallel with Din2
26 Continuous output current	A 1.5 (Load: resistive, inductive)
Analog inputs	
27 Number	1 (Ain0)
28 Signal type	+/- 0..10 VDC, 12 Bit, single ended
Environment	
29 Operating temperature	°C -25...+70

Connection

X1 Hall, inc. encoder, I/O's and CAN

1	GND	Ground of the auxiliary voltage (don't connect with system GND)
2	+U5V	5V output voltage for sensor supply Sensors: encoder, hall
3	B	Inc. encoder, B channel
4	A	Inc. encoder, A channel
5	H3/Inx	Hall sensor 3 / Inc. encoder, index channel
6	H2	Hall sensor 2
7	H1	Hall sensor 1
8	CAN Lo	CAN Low
9	CAN Hi	CAN High
10	Din2/Dout0	Digital input 2 / Digital output 0
11	Din1	Digital input 1
12	Din0	Digital input 0
13	Ain0	Analog input 0
14	GND	Ground for electronic supply voltage
15	+Ue	Electronic supply voltage

X2 Motor

1	+Up	Power supply voltage
2	GND	Ground for sensor supply
3	Ma	Motor phase A
4	Mb	Motor phase B
5	Mc	Motor phase C
6	res.	Reserved

X3 EtherCAT - In port

X4 EtherCAT - Out port

SVTE-A-E65-Profinet Servo Drives

60VDC | 5A
DC motors, BLDC motors

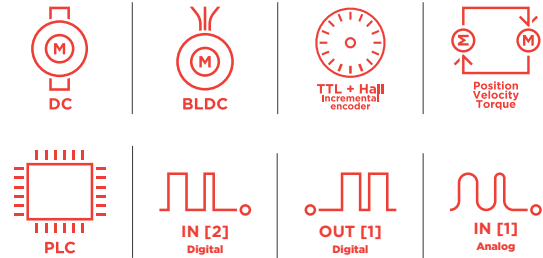
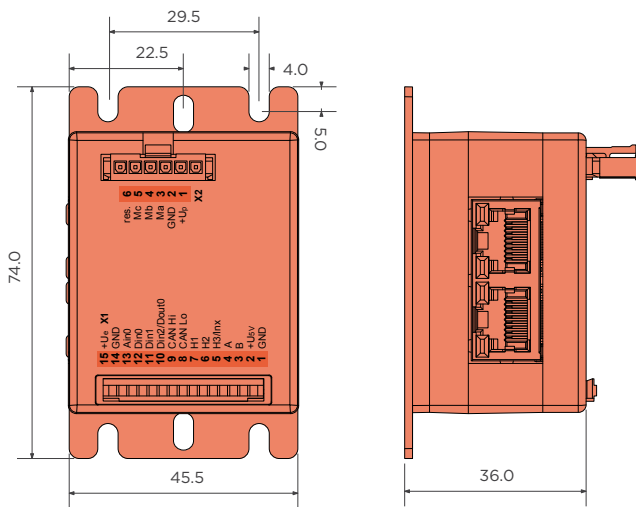

CANopen | PROFIBUS NET

Values	Unit
Power	
1 Electronic supply voltage Ue	VDC 9..30
2 Power supply voltage Up	VDC 9..60
3 Max. output current	A 15
4 Continuous output current @ Up=24VDC	A 5
5 Continuous output current @ Up=48VDC	A 4.3
6 Output voltage	Up to 100%
Motor types	
7 DC motors	yes
8 BLDC motors	yes
9 Stepper motors	no
Mechanical	
10 Size LxWxH	mm 74 x 45.5 x 36
CAN bus	
11 Protocol	DS301
12 Device profile	DS402
13 Galvanically isolated	no
Profinet	
14 Type	Slave
15 Physical layer	100 Base-Tx
16 Max. baudrate	100 Mbit/s
17 Number of ports	2xRJ45 (PORT1, PORT2)
Incremental encoder	
18 Input voltage	VDC 0..5
19 Signal type	open collector, single ended
Hall sensors	
20 Input voltage	VDC 0..5
21 Signal type	open collector, single ended
Digital input	
22 Number	2 (Din0..1)
23 Number (0..30Vdc tolerant)	1 (Din2); Din2 parallel with Dout0 (must not exceed electronic supply voltage)
Digital output	
24 Number	1 (Dout0); Dout0 parallel with Din2
25 Continuous output current	A 1.5 (Load: resistive, inductive)
Analog inputs	
26 Number	1 (Ain0)
27 Signal type	+/- 10 Vdc, 12 Bit, single ended
Environment	
28 Operating temperature	°C -25...+70

Connection

X1 Hall, inc. encoder, I/O's and CAN		
1	GND	Ground of the auxiliary voltage (don't connect with system GND)
2	+U5V	5V output voltage for sensor supply Sensors: encoder, hall
3	B	Inc. encoder, B channel
4	A	Inc. encoder, A channel
5	H3/Inx	Hall sensor 3 / Inc. encoder, index channel
6	H2	Hall sensor 2
7	H1	Hall sensor 1
8	CAN Lo	CAN Low
9	CAN Hi	CAN High
10	Din2/Dout0	Digital input 2 / Digital output 0
11	Din1	Digital input 1
12	Din0	Digital input 0
13	Ain0	Analog input 0
14	res.	Reserved
15	+Ue	Electronic supply voltage
X2 Motor		
1	+Up	Power supply voltage
2	GND	Ground for sensor supply
3	Ma	Motor phase A
4	Mb	Motor phase B
5	Mc	Motor phase C
6	res.	Reserved
X3 Profinet - PORT1		
X4 Profinet - PORT2		

SVTE-A-E67-CanOpen Servo Drives

60VDC | 5A
DC motors, BLDC motors

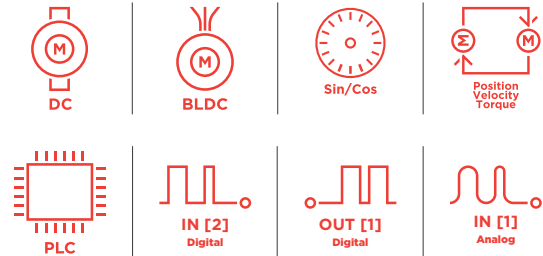
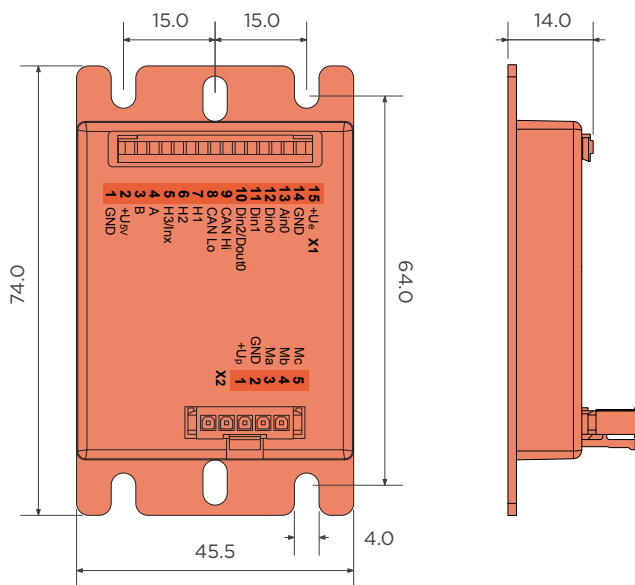

CANopen

Values	Unit
Power	
1 Electronic supply voltage Ue	VDC 9..30
2 Power supply voltage Up	VDC 9..60
3 Max. output current	A 15
4 Continuous output current @ Up=24VDC	A 5
5 Continuous output current @ Up=48VDC	A 4.3
6 Output voltage	Up to 100%
Motor types	
7 DC motors	yes
8 BLDC motors	yes
9 Stepper motors	no
Mechanical	
10 Size LxWxH	mm 74 x 45.5 x 14
CAN bus	
11 Protocol	DS301
12 Device profile	DS402
13 Galvanically isolated	no
Encoder	
14 Input voltage (24VDC tolerant)	1 V peak-peak, differential
15 Signal type	sin / cos, analog, differential
16 Resolution	13 bit per sine period
Digital input	
17 Number	2 (Din0..1)
18 Number (0..30Vdc tolerant)	1 (Din2); Din2 parallel with Dout0 (must not exceed electronic supply voltage)
Digital output	
19 Number	1 (Dout0); Dout0 parallel with Din2
20 Continuous output current	A 1.5 (Load: resistive, inductive)
Analog inputs	
21 Number	1 (Ain0)
22 Signal type	+/- 10 VDC, 12 Bit, single ended
Environment	
23 Operating temperature	°C -25...+70

Connection

X1 Encoder, I/O's and CAN		
1	GND	Ground of the auxiliary voltage (don't connect with system GND)
2	+U5V	5V output voltage for sensor supply Sensors
3	+Cos	Cosine + signal
4	+Sin	Sine + signal
5	res.	Reserved
6	-Cos	Cosine - signal
7	-Sin	Sine - signal
8	CAN Lo	CAN Low
9	CAN Hi	CAN High
10	Din2/Dout0	Digital input 2 / Digital output 0
11	Din1	Digital input 1
12	Din0	Digital input 0
13	Ain0	Analog input 0
14	GND	Ground for electronic supply voltage
15	+Ue	Electronic supply voltage
X2 Motor		
1	+Up	Power supply voltage
2	GND	Ground for sensor supply
3	Ma	Motor phase A
4	Mb	Motor phase B
5	Mc	Motor phase C

SVTE-A-E67-EtherCAT Servo Drives

60VDC | 5A
DC motors, BLDC motors

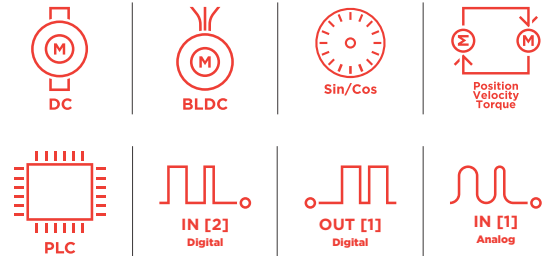
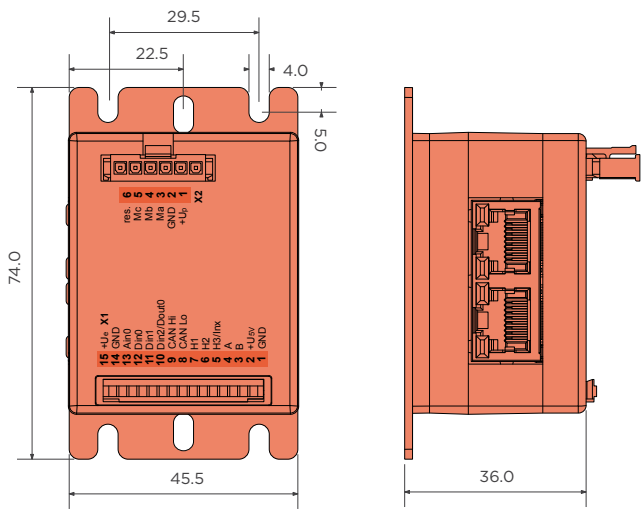

CANopen | EtherCAT

Values	Unit
Power	
1 Electronic supply voltage Ue	VDC 9..30
2 Power supply voltage Up	VDC 9..60
3 Max. output current	A 15
4 Continuous output current @ Up=24VDC	A 5
5 Continuous output current @ Up=48VDC	A 4.3
6 Output voltage	Up to 100%
Motor types	
7 DC motors	yes
8 BLDC motors	yes
9 Stepper motors	no
Mechanical	
10 Size LxWxH	mm 74 x 45.5 x 36
CAN bus	
11 Protocol	DS301
12 Device profile	DS402
13 Galvanically isolated	no
EtherCAT	
14 Type	EtherCAT Slave
15 Physical layer	100 Base-Tx EtherCAT
16 Max. baudrate	100 Mbit/s
17 Number of ports	2xRJ45 (In,Out)
18 Protocol	CoE (CANopen over EtherCAT)
Encoder	
19 Input voltage (24VDC tolerant)	1 V peak-peak, differential
20 Signal type	sin/cos, analog, differential
21 Resolution	13 bit per sine period
Digital input	
22 Number	2 (Din0..1)
23 Number (0..30VDC tolerant)	1 (Din2); Din2 parallel with Dout0 (must not exceed electronic supply voltage)
Digital output	
24 Number	1 (Dout0); Dout0 parallel with Din2
25 Continuous output current	A 1.5 (Load: resistive, inductive)
Analog inputs	
26 Number	1 (Ain0)
27 Signal type	+/- 10 VDC, 12 Bit, single ended
Environment	
27 Operating temperature	°C -25...+70

Connection

X1 Encoder, I/O's and CAN		
1	GND	Ground of the auxiliary voltage (don't connect with system GND)
2	+U5V	5V output voltage for sensor supply Sensors
3	+Cos	Cosine + signal
4	+Sin	Sine + signal
5	res.	Reserved
6	-Cos	Cosine - signal
7	-Sin	Sine - signal
8	CAN Lo	CAN Low
9	CAN Hi	CAN High
10	Din2/Dout0	Digital input 2 / Digital output 0
11	Din1	Digital input 1
12	Din0	Digital input 0
13	Ain0	Analog input 0
14	GND	Ground for electronic supply voltage
15	+Ue	Electronic supply voltage
X2 Motor		
1	+Up	Power supply voltage
2	GND	Ground for sensor supply
3	Ma	Motor phase A
4	Mb	Motor phase B
5	Mc	Motor phase C
6	res.	Reserved
X3 EtherCAT - In port		
X4 EtherCAT - Out port		

SVTE-A-E67-Profinet Servo Drives

60VDC | 5A
DC motors, BLDC motors

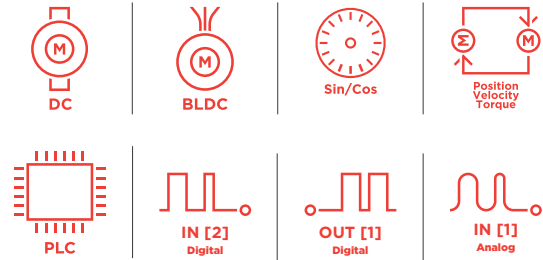
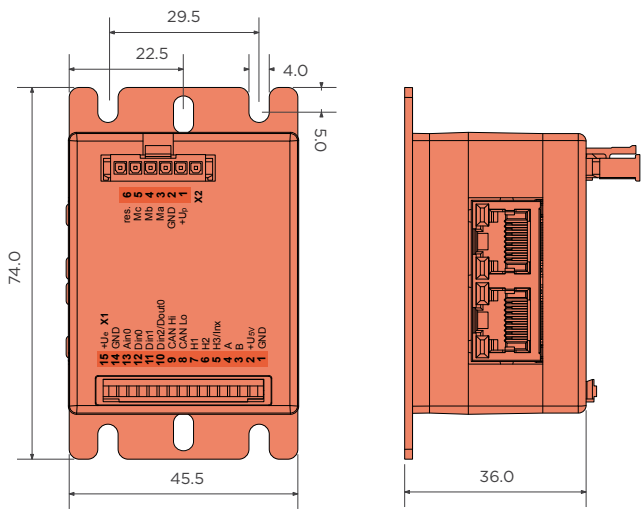

CANopen | PROFIBUS NET

Values	Unit
Power	
1 Electronic supply voltage Ue	VDC 9..30
2 Power supply voltage Up	VDC 9..60
3 Max. output current	A 15
4 Continuous output current @ Up=24VDC	A 5
5 Continuous output current @ Up=48VDC	A 4.3
6 Output voltage	Up to 100%
Motor types	
7 DC motors	yes
8 BLDC motors	yes
9 Stepper motors	no
Mechanical	
10 Size LxWxH	mm 74 x 45.5 x 36
CAN bus	
11 Protocol	DS301
12 Device profile	DS402
13 Galvanically isolated	no
Profinet	
14 Type	Slave
15 Physical layer	100 Base-Tx
16 Max. baudrate	100 Mbit/s
17 Number of ports	2xRJ45 (PORT1, PORT2)
Encoder	
18 Input voltage (24VDC tolerant)	1 V peak-peak, differential
19 Signal type	sin/cos, analog, differential
20 Resolution	13 bit per sine period
Digital input	
21 Number	2 (Din0..1)
22 Number (0..30VDC tolerant)	1 (Din2); Din2 parallel with Dout0 (must not exceed electronic supply voltage)
Digital output	
23 Number	1 (Dout0); Dout0 parallel with Din2
24 Continuous output current	A 1.5 (Load: resistive, inductive)
Analog inputs	
25 Number	1 (Ain0)
26 Signal type	+/- 10 VDC, 12 Bit, single ended
Environment	
26 Operating temperature	°C -25...+70

Connection

X1 Encoder, I/O's and CAN		
1	GND	Ground of the auxiliary voltage (don't connect with system GND)
2	+U5V	5V output voltage for sensor supply Sensors
3	+Cos	Cosine + signal
4	+Sin	Sine + signal
5	res.	Reserved
6	-Cos	Cosine - signal
7	-Sin	Sine - signal
8	CAN Lo	CAN Low
9	CAN Hi	CAN High
10	Din2/Dout0	Digital input 2 / Digital output 0
11	Din1	Digital input 1
12	Din0	Digital input 0
13	Ain0	Analog input 0
14	GND	Ground for electronic supply voltage
15	+Ue	Electronic supply voltage
X2 Motor		
1	+Up	Power supply voltage
2	GND	Ground for sensor supply
3	Ma	Motor phase A
4	Mb	Motor phase B
5	Mc	Motor phase C
6	res.	Reserved
X3 Profinet - In port		
X4 Profinet - Out port		

SVTE-A-S40-CanOpen Stepper Drives

60VDC | 7A
Stepper motors

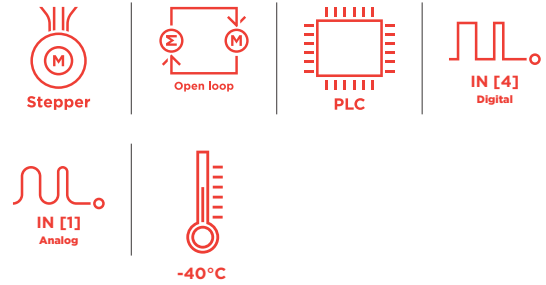
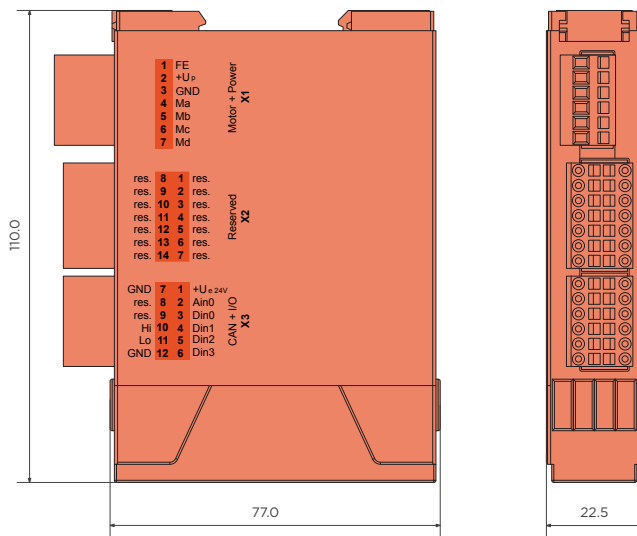

CANopen

Values	Unit
Power	
1 Electronic supply voltage U _e	VDC 9..30
2 Power supply voltage U _p	VDC 9..60
3 Max. output current	A 20
4 Continuous output current @ U _p =24VDC	A 7
5 Continuous output current @ U _p =48VDC	A 6
6 Output voltage	Up to 85%
Motor types	
7 DC motors	no
8 BLDC motors	no
9 Stepper motors	yes
Mechanical	
10 Size LxWxH	mm 110 x 22.5 x 77
CAN bus	
11 Protocol	DS301
12 Device profile	DS402
13 Galvanically isolated	no
Digital input	
14 Number	4 (Din0..3)
Analog inputs	
15 Number	1 (Ain0)
16 Signal type	0..10 VDC, 12 Bit, single ended
Environment	
17 Operating temperature	°C -40...+70

Connection

X1 Motor		
1	FE	Functional earth
2	+Up	Power supply voltage
3	GND	Ground for sensor supply
4	Ma	Motor phase A
5	Mb	Motor phase B
6	Mc	Motor phase C
7	Md	Motor phase D
X2 Reserved		
1	res.	Reserved
2	res.	Reserved
3	res.	Reserved
4	res.	Reserved
5	res.	Reserved
6	res.	Reserved
7	+U5V	5V output voltage for sensor supply (auxiliary voltage)
8	res.	Reserved
9	res.	Reserved
10	res.	Reserved
11	res.	Reserved
12	res.	Reserved
13	res.	Reserved
14	GND	Ground for sensor supply (don't connect with system GND)
X3 I/O's and CAN		
1	+Ue24V	Electronic supply voltage
2	Ain0	Analog input 0
3	Din0	Digital input 0
4	Din1	Digital input 1
5	Din2	Digital input 2
6	Din3	Digital input 3
7	GND	Ground for electronic supply voltage
8	res.	Reserved
9	res.	Reserved
10	CAN Hi	CAN High
11	CAN Lo	CAN Low
12	CAN GND	CAN Ground

SVTE-A-S45-CanOpen Stepper Drives

60VDC | 7A
Stepper motors

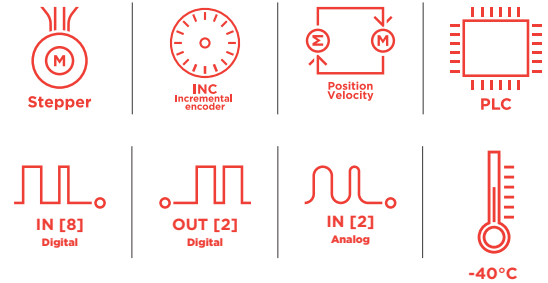
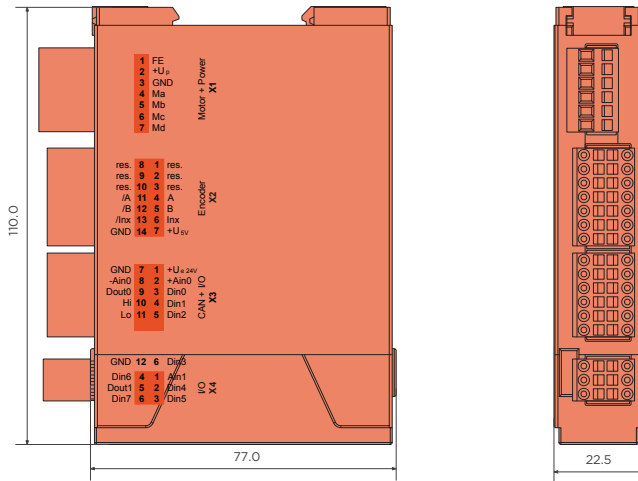

CANopen

Values	Unit
Power	
1 Electronic supply voltage U _e	VDC 9..30
2 Power supply voltage U _p	VDC 9..60
3 Max. output current	A 20
4 Continuous output current @ U _p =24VDC	A 7
5 Continuous output current @ U _p =48VDC	A 6
6 Output voltage	Up to 85%
Motor types	
7 DC motors	no
8 BLDC motors	no
9 Stepper motors	yes
Mechanical	
10 Size LxWxH	mm 110 x 22.5 x 77
CAN bus	
11 Protocol	DS301
12 Device profile	DS402
13 Galvanically isolated	no
Incremental encoder	
14 Input voltage (24VDC tolerant)	VDC 0..5
15 Signal type	open collector, single ended, differential
Digital input	
16 Number	8 (Din0..7)
Digital output	
17 Number	2 (Dout0..Dout1)
18 Continuous output current	A 1.5 (Load: resistive, inductive)
Analog inputs	
19 Number	2 (Ain0..1)
20 Signal type - Ain0	+/- 10 VDC, 12 Bit, differential
21 Signal type - Ain1	+/- 10 VDC, 12 Bit, single ended
Environment	
22 Operating temperature	°C -40...+70

Connection

X1 Motor		
1	FE	Functional earth
2	+Up	Power supply voltage
3	GND	Ground for sensor supply
4	Ma	Motor phase A
5	Mb	Motor phase B
6	Mc	Motor phase C
7	Md	Motor phase D
X2 Inc. encoder		
1	res.	Reserved
2	res.	Reserved
3	res.	Reserved
4	A	Inc. encoder, A channel
5	B	Inc. encoder, B channel
6	Inx	Inc. encoder, index channel
7	+U5V	5V output voltage for sensor supply: encoder
8	res.	Reserved
9	res.	Reserved
10	res.	Reserved
11	/A	Inc. encoder, A channel inverted
12	/B	Inc. encoder, B channel inverted
13	/Inx	Inc. encoder, index channel inverted
14	GND	Ground for sensor supply (don't connect with system GND)
X3 I/O's and CAN		
1	+Ue24V	Electronic supply voltage
2	+Ain0	Analog input 0, positive
3	Din0	Digital input 0
4	Din1	Digital input 1
5	Din2	Digital input 2
6	Din3	Digital input 3
7	GND	Ground for electronic supply voltage
8	-Ain0	Analog input 0, negative
9	Dout0	Digital output 0
10	CAN Hi	CAN High
11	CAN Lo	CAN Low
12	CAN GND	CAN Ground
X4 I/O's		
1	Ain1	Analog input 1
2	Din4	Digital input 4
3	Din5	Digital input 5
4	Din6	Digital output 6
5	Dout1	Digital output 1
6	Din7	Digital input 7

SVTE-A-S60-CanOpen Stepper Drives

60VDC | 3.5A
Stepper motors

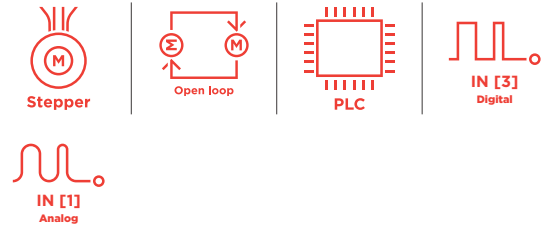
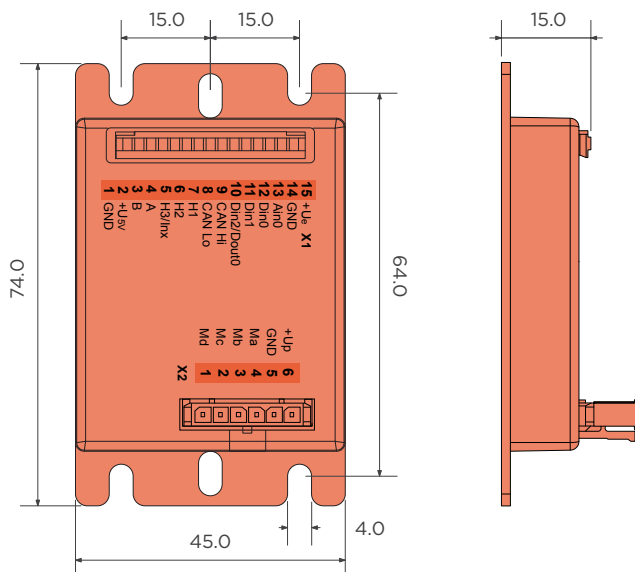

CANopen

Values	Unit
Power	
1 Electronic supply voltage Ue	VDC 9..30
2 Power supply voltage Up	VDC 9..60
3 Max. output current	A 10
4 Continuous output current @ Up=24VDC	A 3.5
5 Continuous output current @ Up=48VDC	A 3
6 Output voltage	Up to 85%
Motor types	
7 DC motors	no
8 BLDC motors	no
9 Stepper motors	yes
Mechanical	
10 Size LxWxH	mm 74 x 45.5 x 14
CAN bus	
11 Protocol	DS301
12 Device profile	DS402
13 Galvanically isolated	no
Digital input	
14 Number	3 (Din0..2)
Analog inputs	
15 Number	1 (Ain0)
16 Signal type	0..10 VDC, 12 Bit, single ended
Environment	
17 Operating temperature	°C -25...+70

Connection

X3 I/O's and CAN

1	GND	Ground of the auxiliary voltage (don't connect with system GND)
2	+U5V	5V output voltage (auxiliary voltage)
3	res.	Reserved
4	res.	Reserved
5	res.	Reserved
6	res.	Reserved
7	res.	Reserved
8	CAN Lo	CAN Low
9	CAN Hi	CAN High
10	Din2	Digital input 2
11	Din1	Digital input 1
12	Din0	Digital input 0
13	Ain0	Analog input 0
14	GND	Ground for electronic supply voltage
15	+Ue	Electronic supply voltage

X2 Motor

1	+Up	Power supply voltage
2	GND	Ground for sensor supply
3	Ma	Motor phase A
4	Mb	Motor phase B
5	Mc	Motor phase C
6	Md	Motor phase D

SVTE-A-S65-CanOpen Stepper Drives

60VDC | 3.5A
Stepper motors

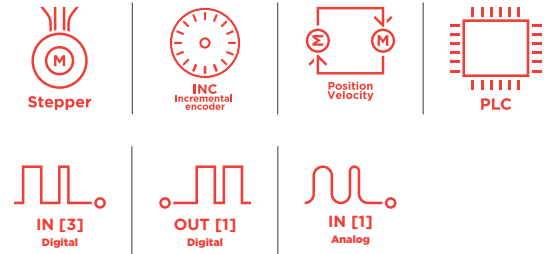
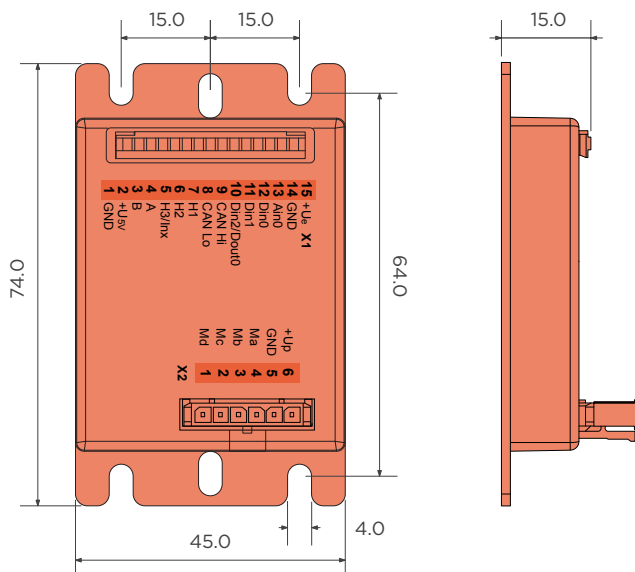

CANopen

Values	Unit
Power	
1 Electronic supply voltage Ue	VDC 9..30
2 Power supply voltage Up	VDC 9..60
3 Max. output current	A 10
4 Continuous output current @ Up=24VDC	A 3.5
5 Continuous output current @ Up=48VDC	A 3
6 Output voltage	Up to 85%
Motor types	
7 DC motors	no
8 BLDC motors	no
9 Stepper motors	yes
Mechanical	
10 Size LxWxH	mm 74 x 45.5 x 14
CAN bus	
11 Protocol	DS301
12 Device profile	DS402
13 Galvanically isolated	no
Incremental encoder	
14 Input voltage	VDC 0..5
15 Signal type	open collector, single ended
Digital input	
16 Number	3 (Din0..2); Din2 parallel with Dout0 (must not exceed electronic supply voltage)
Digital output	
17 Number	1 (Dout0); Dout0 parallel with Din2
18 Continuous output current	1.5 (Load: resistive, inductive)
Analog inputs	
19 Number	1 (Ain0)
20 Signal type - Ain0	+/- 10 VDC, 12 Bit, single ended
Environment	
22 Operating temperature	°C -25...+70

Connection

X3 I/O's and CAN

1	GND	Ground of the auxiliary voltage (don't connect with system GND)
2	+U5V	5V output voltage for supply encoder
3	B	Inc. encoder, B channel
4	A	Inc. encoder, A channel
5	Inx	Inc. encoder, index channel
6	res.	Reserved
7	res.	Reserved
8	CAN Lo	CAN Low
9	CAN Hi	CAN High
10	Din2/Dout0	Digital input 2 / Digital output 0
11	Din1	Digital input 1
12	Din0	Digital input 0
13	Ain0	Analog input 0
14	GND	Ground for electronic supply voltage
15	+Ue	Electronic supply voltage

X2 Motor

1	+Up	Power supply voltage
2	GND	Ground for sensor supply
3	Ma	Motor phase A
4	Mb	Motor phase B
5	Mc	Motor phase C
6	Md	Motor phase D

SVTE-4AX-CanOpen

4 Axes Servo Drives

48VDC | 5A/Axis
 BLDC motors, Brushless motors,
 Stepper Motors, Linear Motors

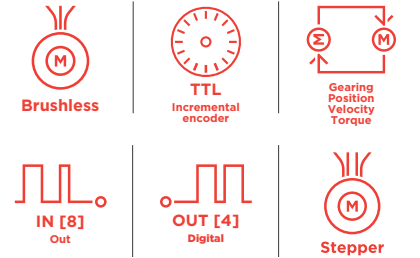
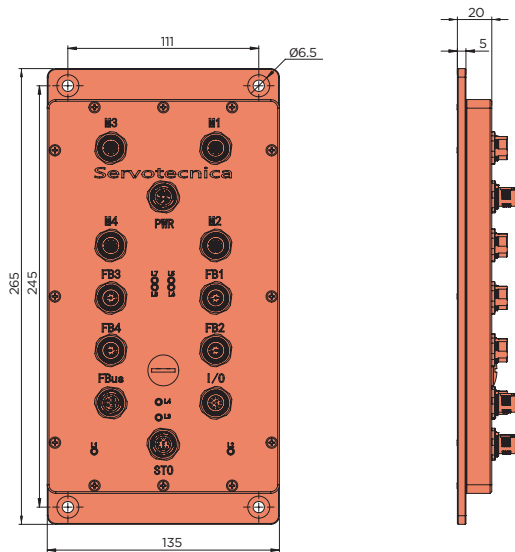

CANopen

Values	Unit
Power	
1 Electronic supply voltage Ue	VDC 19..30
2 Power supply voltage Up	VDC 19..60
3 Max. output current	A 10A/axis
4 Continuous output current @ Up=48VVDC	A 5A/axis
5 Output voltage	up to 96%
Motor types	
6 Brushless	yes
7 DC motors	no
8 BLDC motors	yes
9 Stepper motors	yes
Mechanical	
10 Size LxWxH	mm 265x135x20
Communication CAN bus	
11 Protocol	DS301
12 Device profile	DS402
13 Galvanically isolated	yes
Incremental encoder	
14 Input voltage	VDC 0..5
15 Signal type	differential, single ended
Digital input	
16 Number	8 (Din0..7)
Digital output	
17 Number	4 (Dout0..3)
18 Continuous output current	A 0.5 (Load: resistive, inductive)
Environment	
19 Operating temperature	°C 0..50°C

Connection

M1..M4	BLDC/Brushless	Stepper
1	Temp.Sensor	PT1000
2	Temp.Sensor	PT1000
3	Bk+	Brake +
4	Bk-	Brake -
5	Mb	Motor phase B
6	N.C.	Non Connected
7	Ma	Motor phase A
8	Mc	Motor phase C
FB1..FB4 Feedback		
1	+U5V	5V output voltage for sensor supply
2	A	Inc. encoder, A channel
3	/A	Inc. encoder, A channel inverted
4	B	Inc. encoder, B channel
5	/B	Inc. encoder, B channel inverted
6	Inx	Inc. encoder, index channel
7	/Inx	Inc. encoder, index channel inverted
8	GND	Ground for sensor supplychannel inverted
STO Logic power supply / STO		
1	+Ue24V	Electronic supply voltage
2	GND	Ground for electronic supply voltage
3	N.C.	Non Connected
4	FE	Functional earth
5	STO1	Safety Torque Off 2 +24Vdc
6	STO2	Safety Torque Off 1 +24Vdc
7	STO Com	Safety Torque Com
8	STO Out	Safety Torque Off Output
Fbus CanBus		
1	CAN Lo	CAN Low
2	N.C.	Non Connected
3	CAN GND	CAN Ground
4	CAN Hi	CAN High
5	CAN GND	CAN Ground
I/O Digital I/O		
1	Din5	Digital Input 5
2	Din3	Digital Input 3
3	Din2	Digital Input 2
4	Din0	Digital Input 0
5	Dout0	Digital Output 0
6	Dout1	Digital Output 1
7	Dout2	Digital Output 2
8	Dout3	Digital Output 3
9	Din6	Digital Input 6
10	Din4	Digital Input 4
11	Din1	Digital Input 1
12	Din8	Digital Input 8
PWR Power supply		
1	+Up	Power supply voltage
2	+Up	Power supply voltage
3	GND	Ground for power supply voltage
4	GND	Ground for power supply voltage

SVTE-4AX-CanOpen

4 Axes Servo Drives

48VDC | 5A/Axis
 BLDC motors, Brushless motors,
 Stepper Motors, Linear Motors

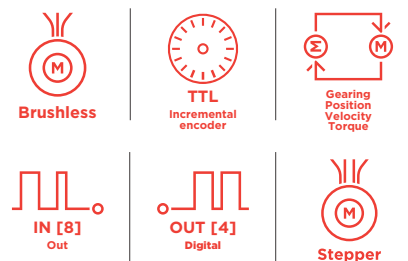
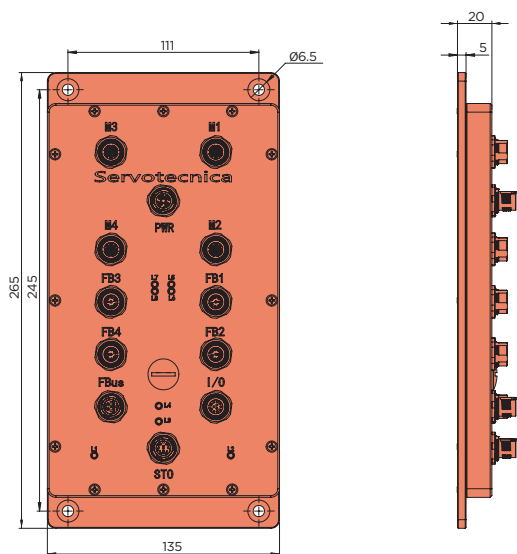

IO-Link

Values	Unit
Power	
1 Electronic supply voltage Ue	VDC 19..30
2 Power supply voltage Up	VDC 19..60
3 Max. output current	A 10A/axis
4 Continuous output current @ Up=48VVDC	A 5A/axis
5 Output voltage	up to 96%
Motor types	
6 Brushless	yes
7 DC motors	no
8 BLDC motors	yes
9 Stepper motors	yes
Mechanical	
10 Size LxWxH	mm 265x135x20
Communication IO-Link	
11 Protocol	IO-Link
12 Galvanically isolated	yes
Incremental encoder	
13 Input voltage	VDC 0..5
14 Signal type	differential, single ended
Digital input	
15 Number	8 (Din0..7)
Digital output	
16 Number	4 (Dout0..3)
17 Continuous output current	A 0.5 (Load: resistive, inductive)
Environment	
18 Operating temperature	°C 0..50°C

Connection

M1..M4	BLDC/Brushless	Stepper
1	Temp.Sensor	PT1000
2	Temp.Sensor	PT1000
3	Bk+	Brake +
4	Bk-	Brake -
5	Mb	Motor phase B
6	N.C.	Non Connected
7	Ma	Motor phase A
8	Mc	Motor phase C
FB1..FB4 Feedback		
1	+U5V	5V output voltage for sensor supply
2	A	Inc. encoder, A channel
3	/A	Inc. encoder, A channel inverted
4	B	Inc. encoder, B channel
5	/B	Inc. encoder, B channel inverted
6	Inx	Inc. encoder, index channel
7	/Inx	Inc. encoder, index channel inverted
8	GND	Ground for sensor supplychannel inverted
STO Logic power supply / STO		
1	+Ue24V	Electronic supply voltage
2	GND	Ground for electronic supply voltage
3	N.C.	Non Connected
4	FE	Functional earth
5	STO1	Safety Torque Off 2 +24Vdc
6	STO2	Safety Torque Off 1 +24Vdc
7	STO Com	Safety Torque Com
8	STO Out	Safety Torque Off Output
Fbus IO-Link		
1	Vplus	Vplus
2	N.C.	Non Connected
3	N.C.	Non Connected
4	CQ	CQ
5	N.C.	Non Connected
I/O Digital I/O		
1	Din5	Digital Input 5
2	Din3	Digital Input 3
3	Din2	Digital Input 2
4	Din0	Digital Input 0
5	Dout0	Digital Output 0
6	Dout1	Digital Output 1
7	Dout2	Digital Output 2
8	Dout3	Digital Output 3
9	Din6	Digital Input 6
10	Din4	Digital Input 4
11	Din1	Digital Input 1
12	Din8	Digital Input 8
PWR Power supply		
1	+Up	Power supply voltage
2	+Up	Power supply voltage
3	GND	Ground for power supply voltage
4	GND	Ground for power supply voltage